

MIECZYŚLAW PIWOWARCZYK

ZAJĘCIA RĘKODZIELNICZE
W SZKOLE

ROBOTY Z RÓŻNYCH MATERIAŁÓW

A T L A S

Z 238 RYCINAMI



KSIĄŻNICA-ATLAS * LWÓW-WARSZAWA
1939

MIECZYŚLAW PIWOWARCZYK

ZAJĘCIA RĘKODZIELNICZE
W SZKOLE

ROBOTY Z RÓŻNYCH MATERIAŁÓW

A T L A S

Z 238 RYCINAMI



KSIĄŻNICA-ATLAS * LWÓW-WARSZAWA
1939



3030

WYDAWCA: KSIĄŻNICA-ATLAS S. A., ZJEDNOCZONE ZAKŁADY KARTO-
GRAFICZNE I WYDAWNICZE T. N. S. W., LWÓW, CZARNIECKIEGO 12
ODDZIAŁ: WARSZAWA, NOWY ŚWIAT 59

ODBITO W ZAKŁADACH GRAFICZNYCH SP. AKC., KSIĄŻNICA-ATLAS
LWÓW, GEN. ROZWADOWSKIEGO 20

COPYRIGHT, 1939, BY S. A. KSIĄŻNICA-ATLAS, LWÓW-WARSZAWA
PRINTED IN POLAND

Ċ IX

Palik, tabliczki i ogrodzenie

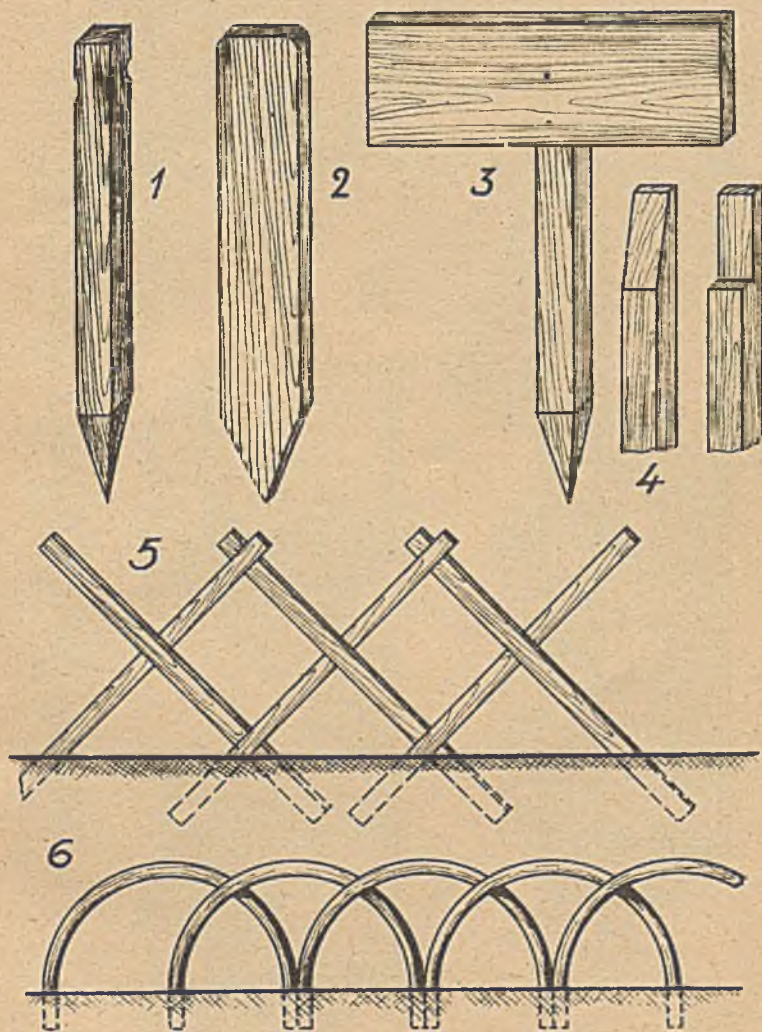

Skrzynki do hodowli roślin

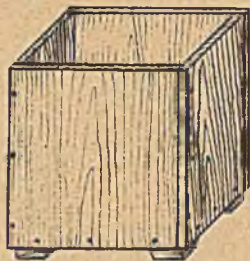

7

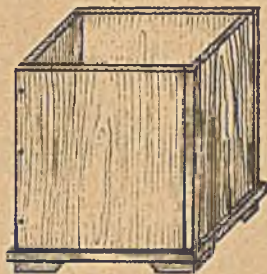

8

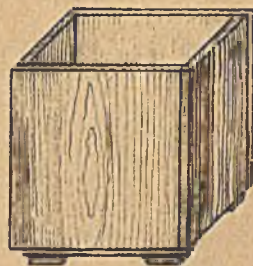

9

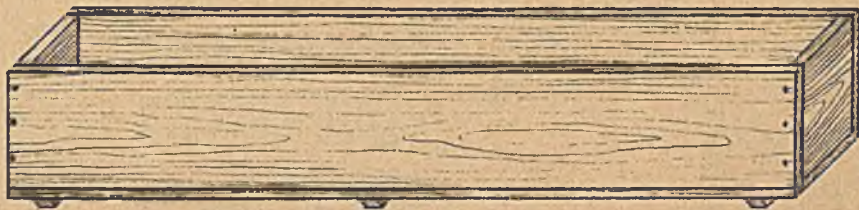

10

Gotebniki

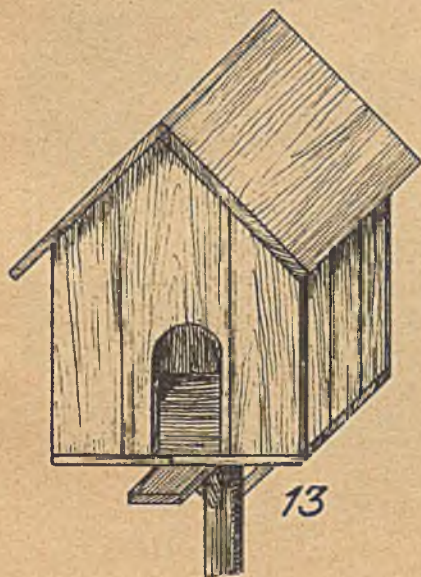
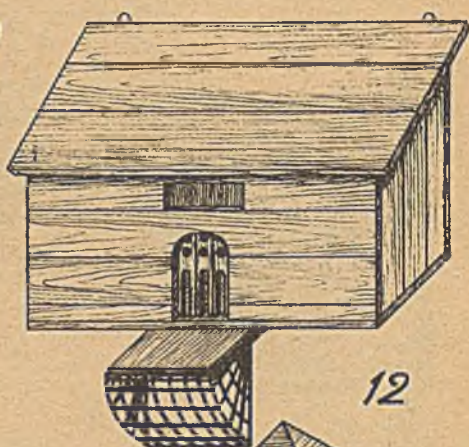
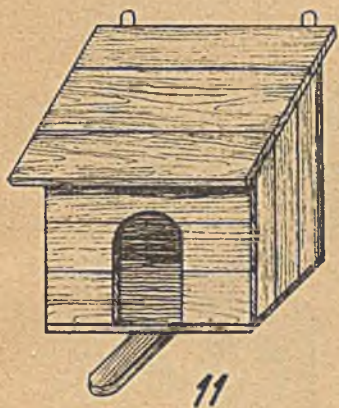

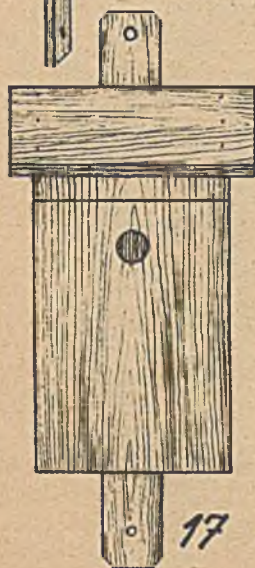
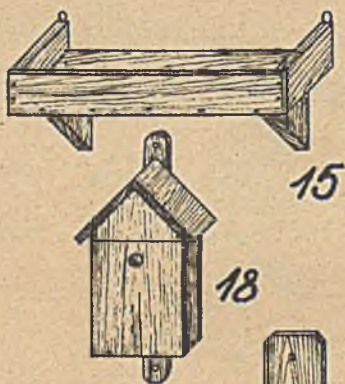
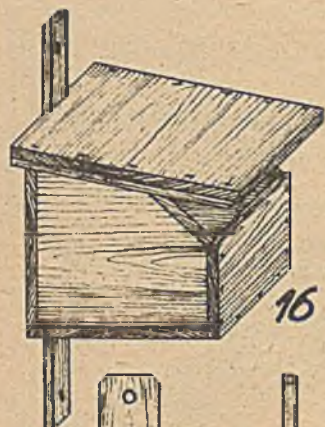
Póteczki i domki dla ptaków

Karmidetka i poidetka

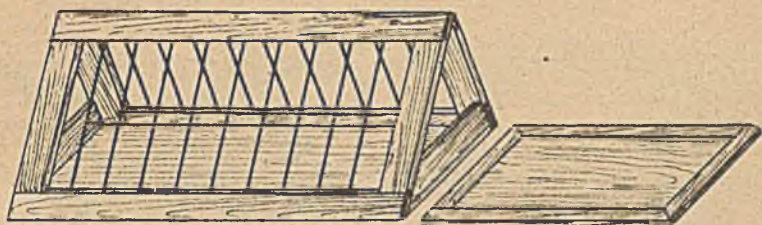

19

20

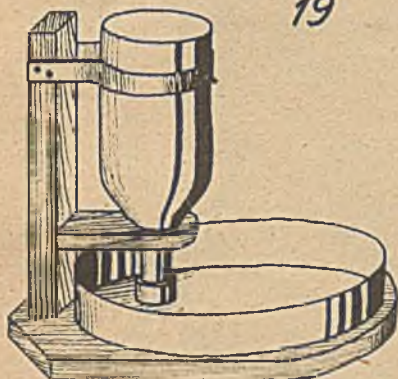

21

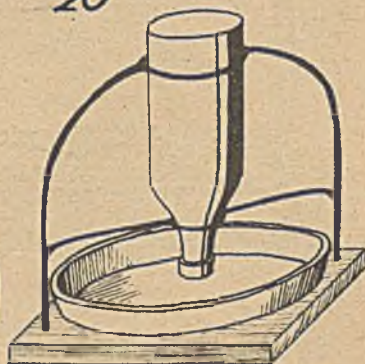

22



23

Ławki i stoliki ogrodowe



24



25

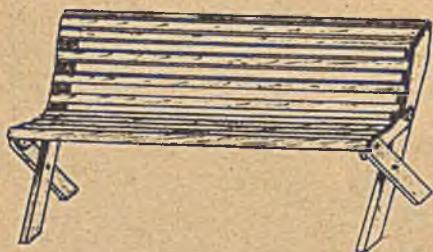

26

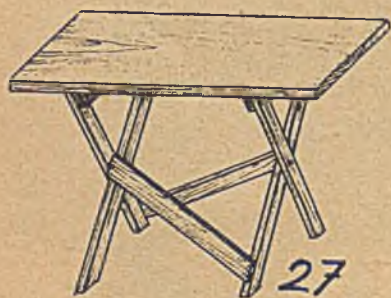

27



28



Wiwarium

29

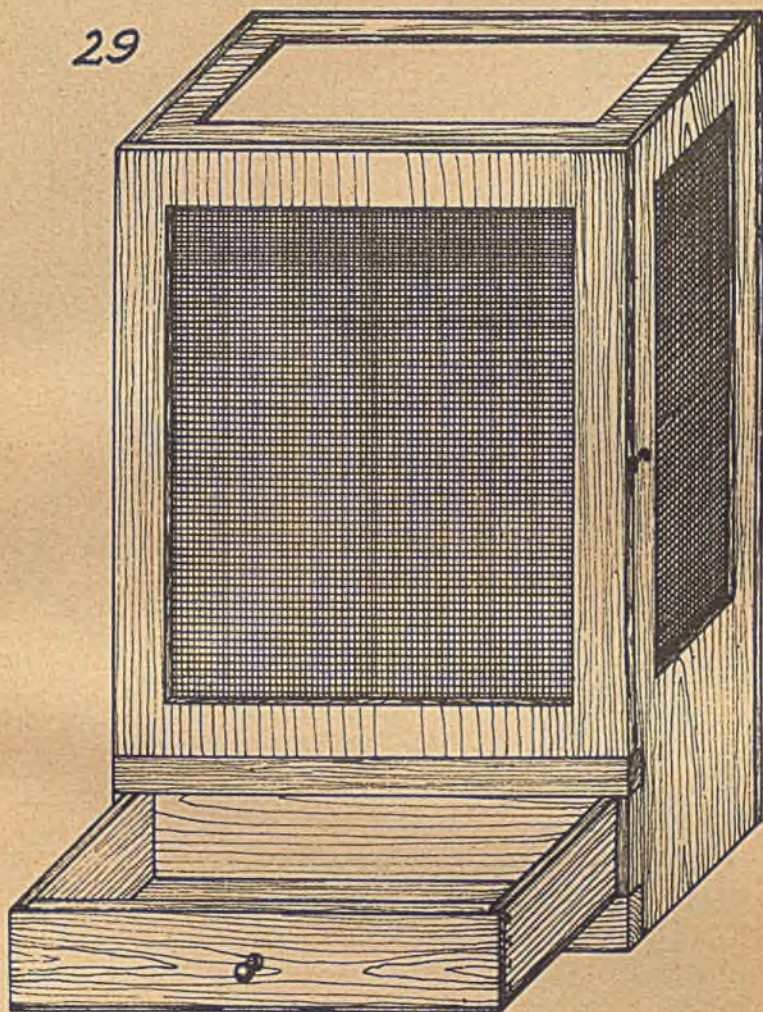

Terrarium

30

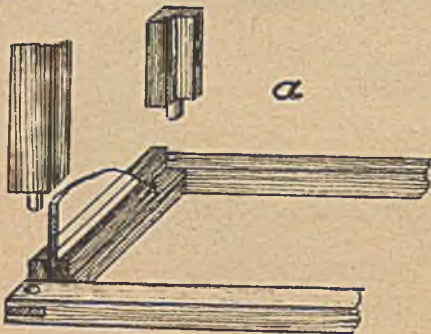
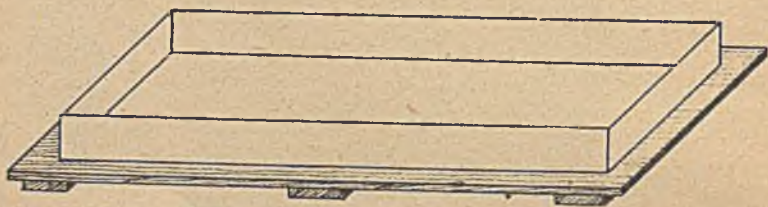
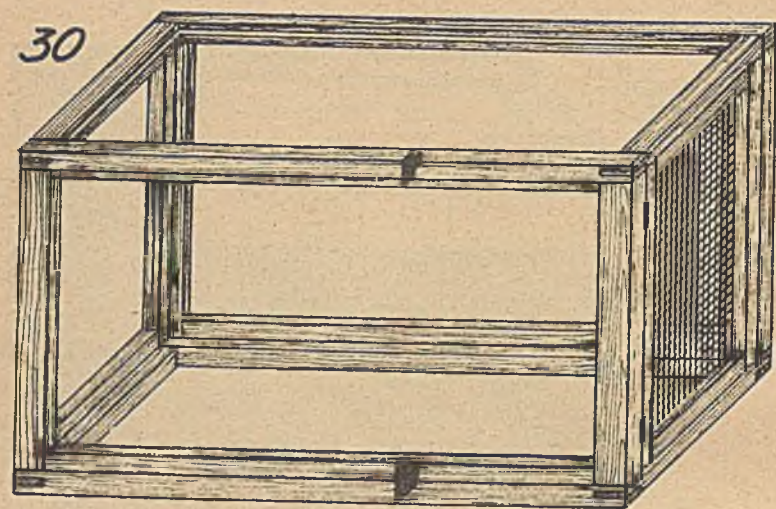

Akwarium metalowe

31

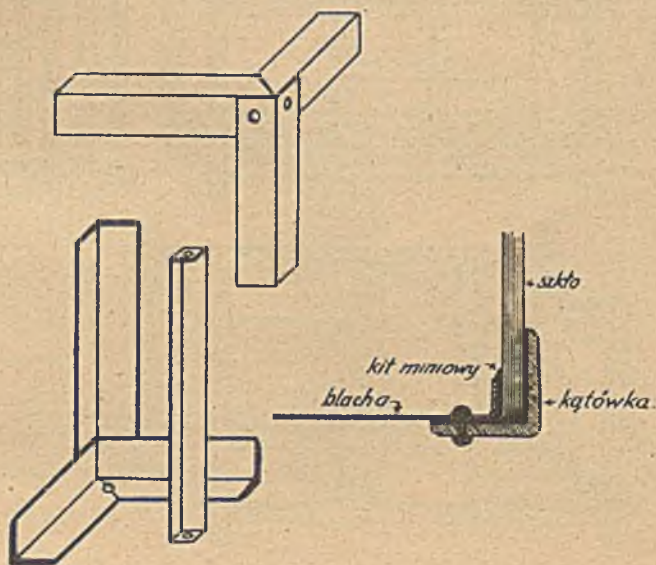
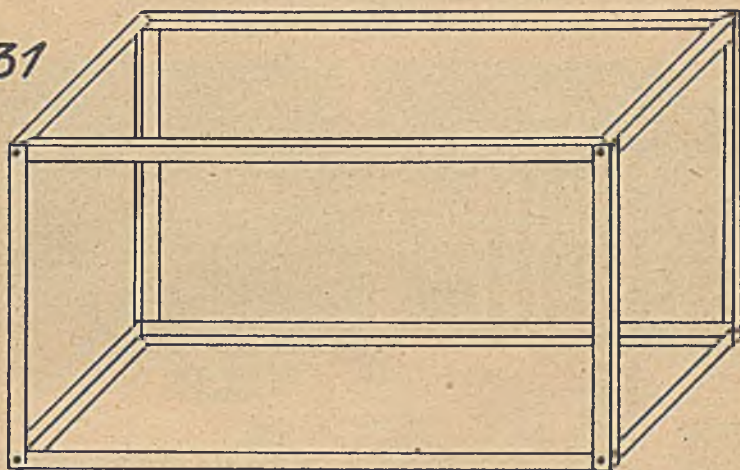

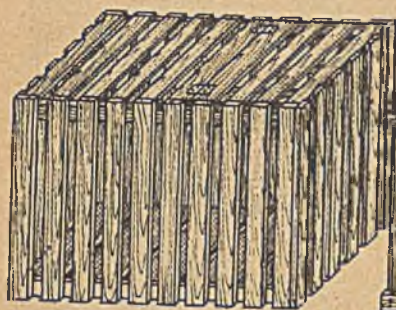
Klatki dla drobiu

32

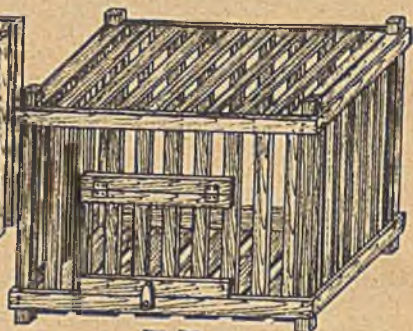

33

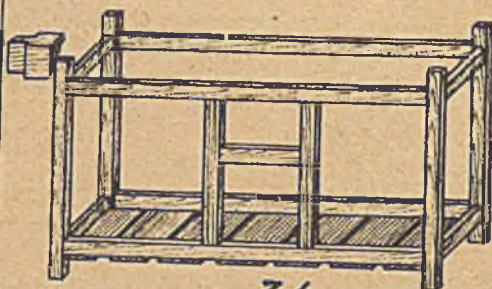

34

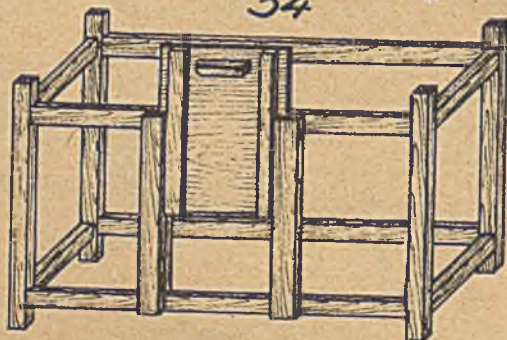

35

Klatki

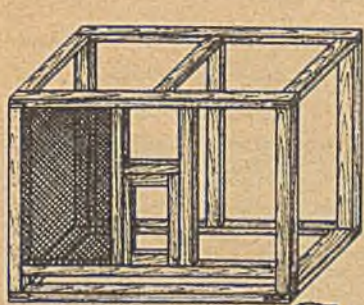

36



37



38

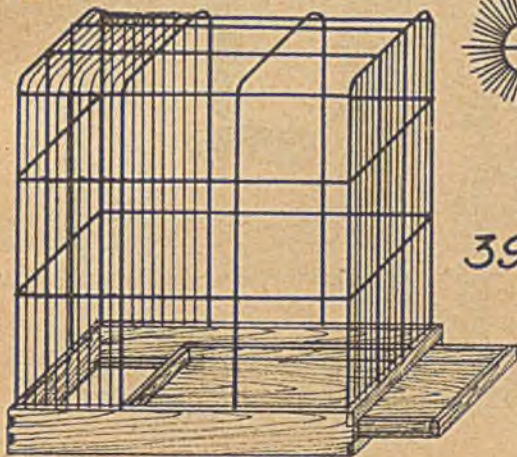

39



Inspekty

40

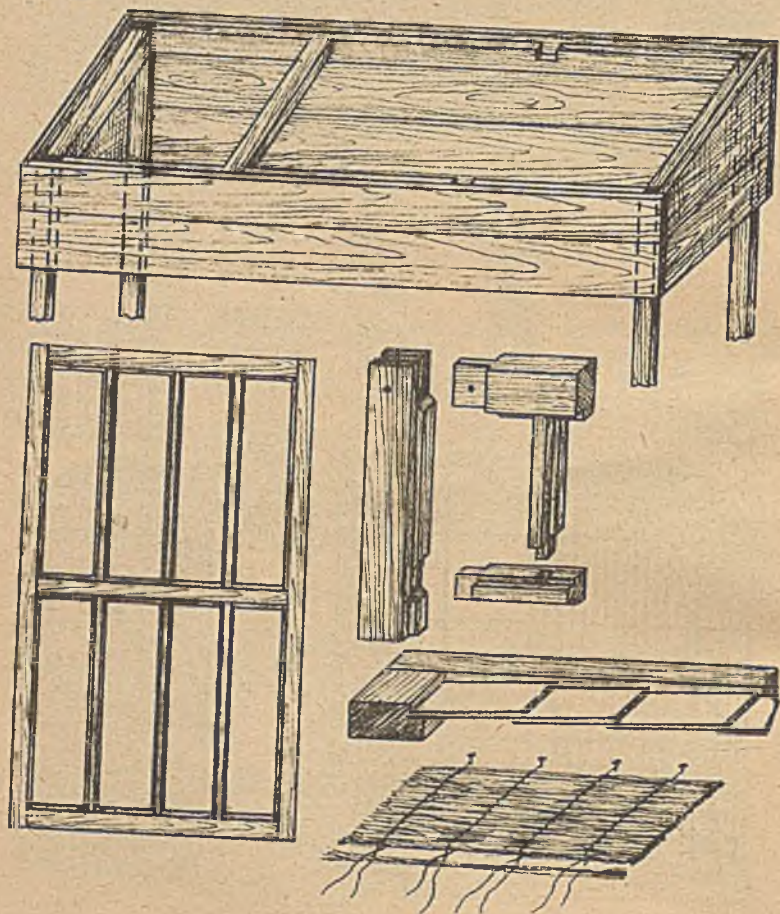

Sprzet ogrodniczy

41



42



43

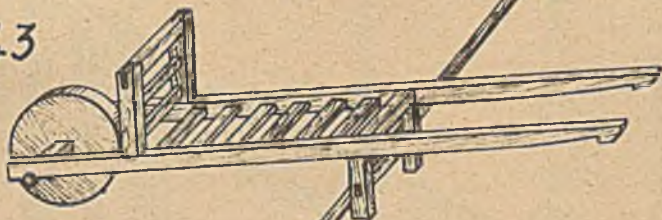

44

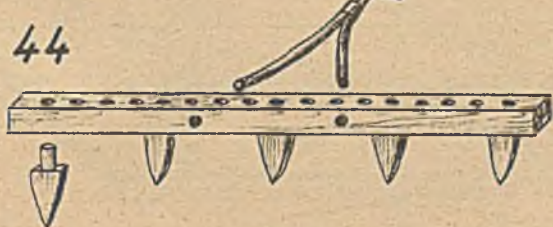

45



Prasa , łapka, listwy do obrazu

46

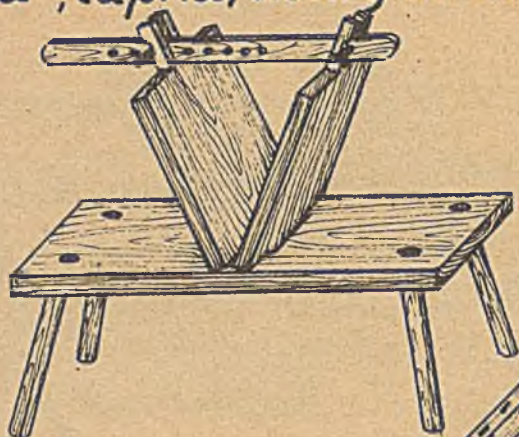

47

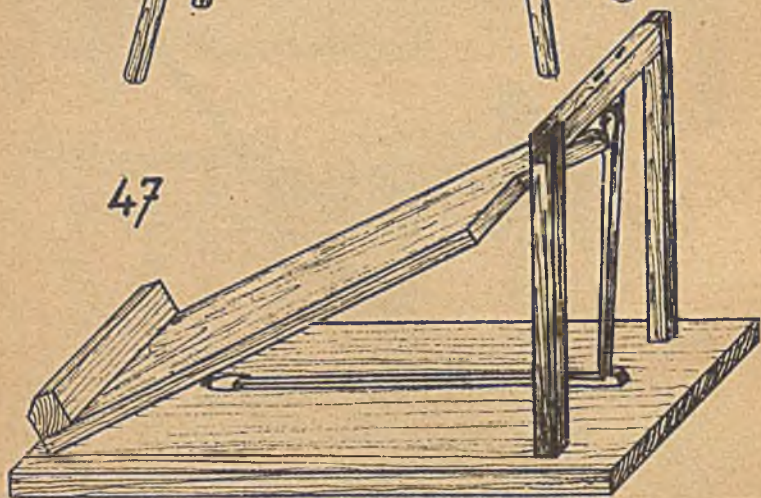

48



Rozszerzalność metali

49

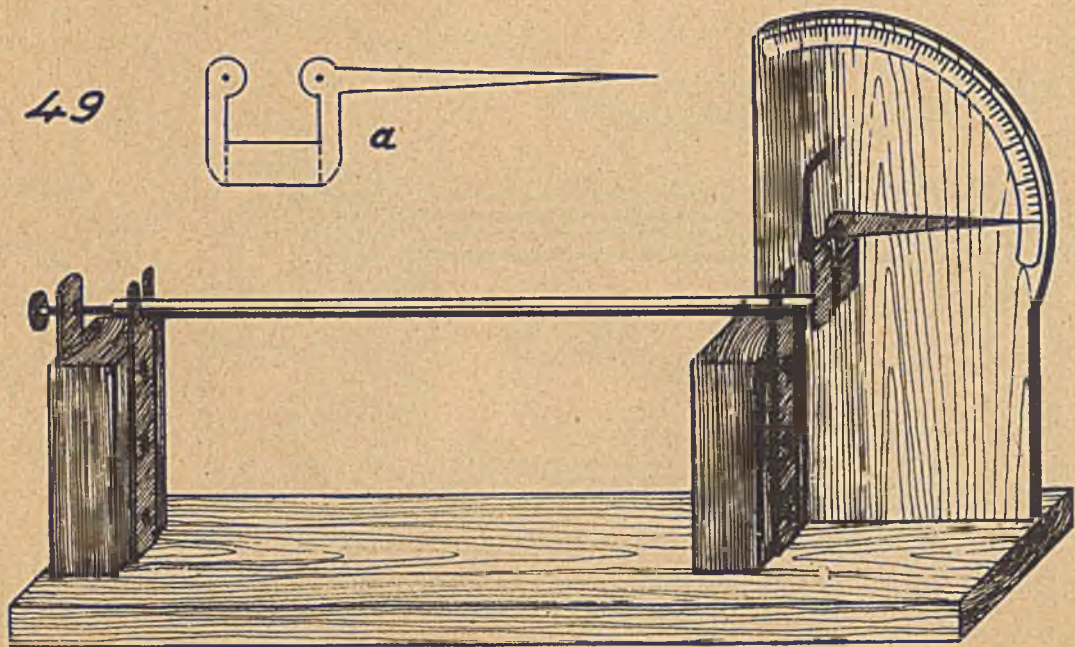
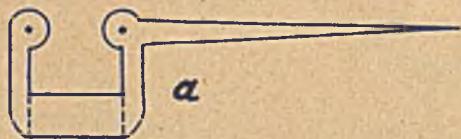

Rozszerzalność metali

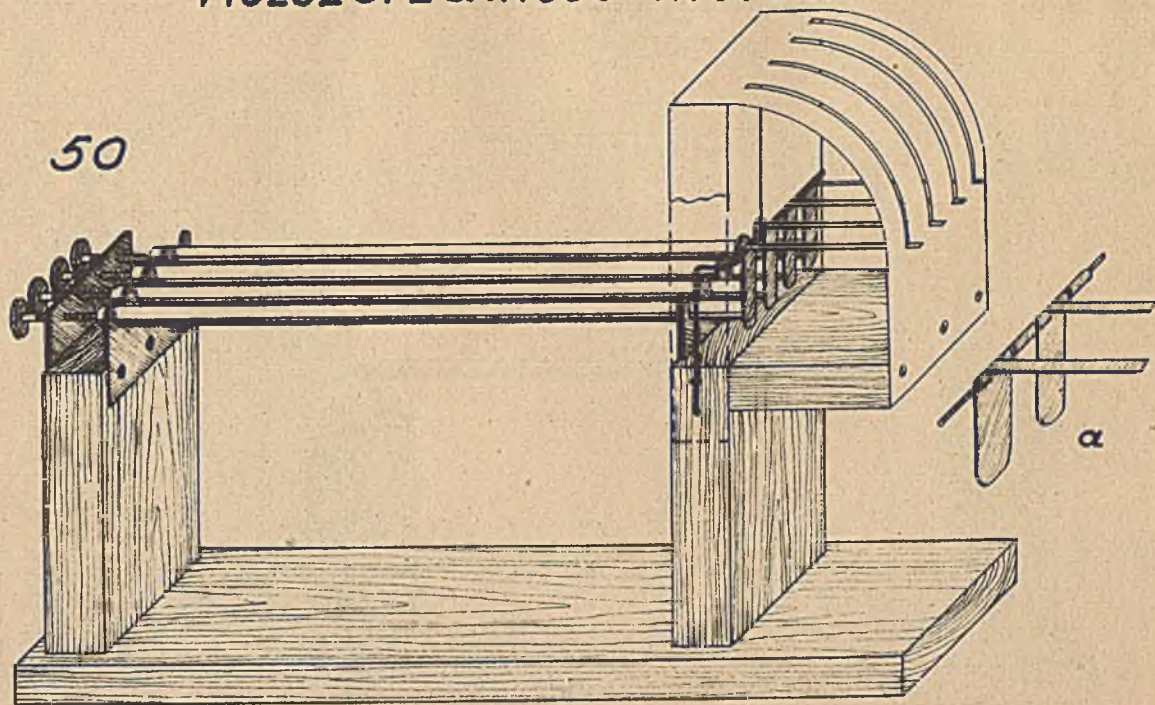

Formy użytkowe ze szkła

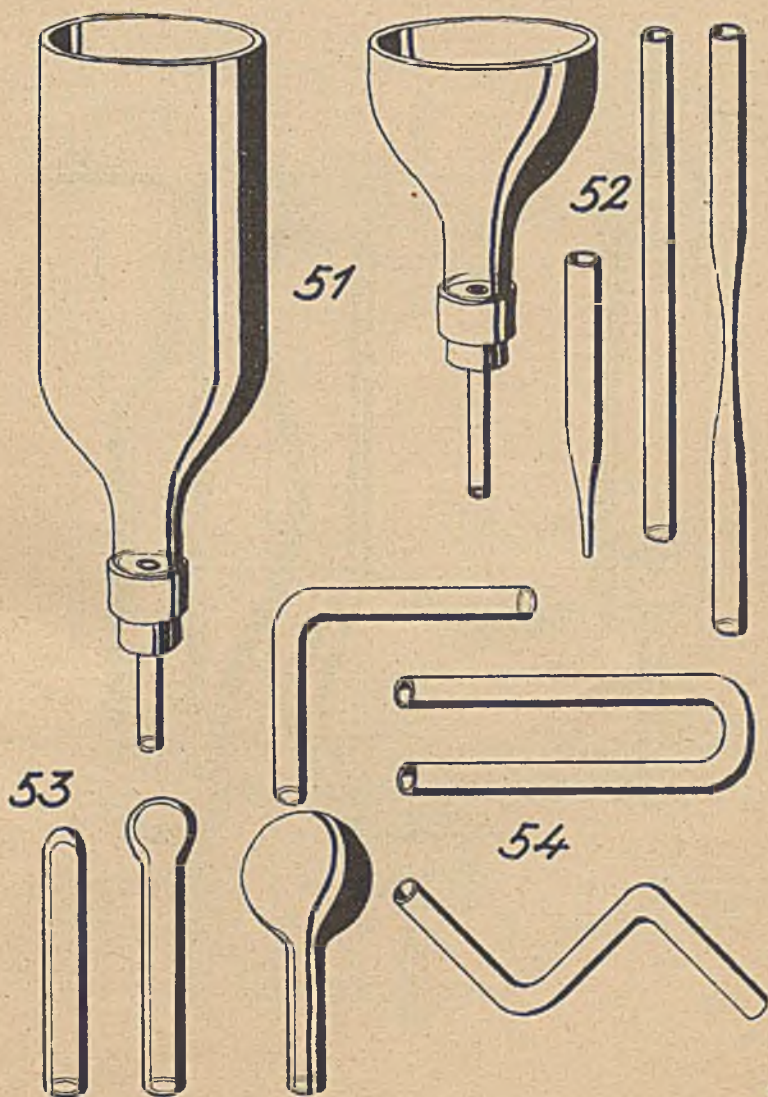

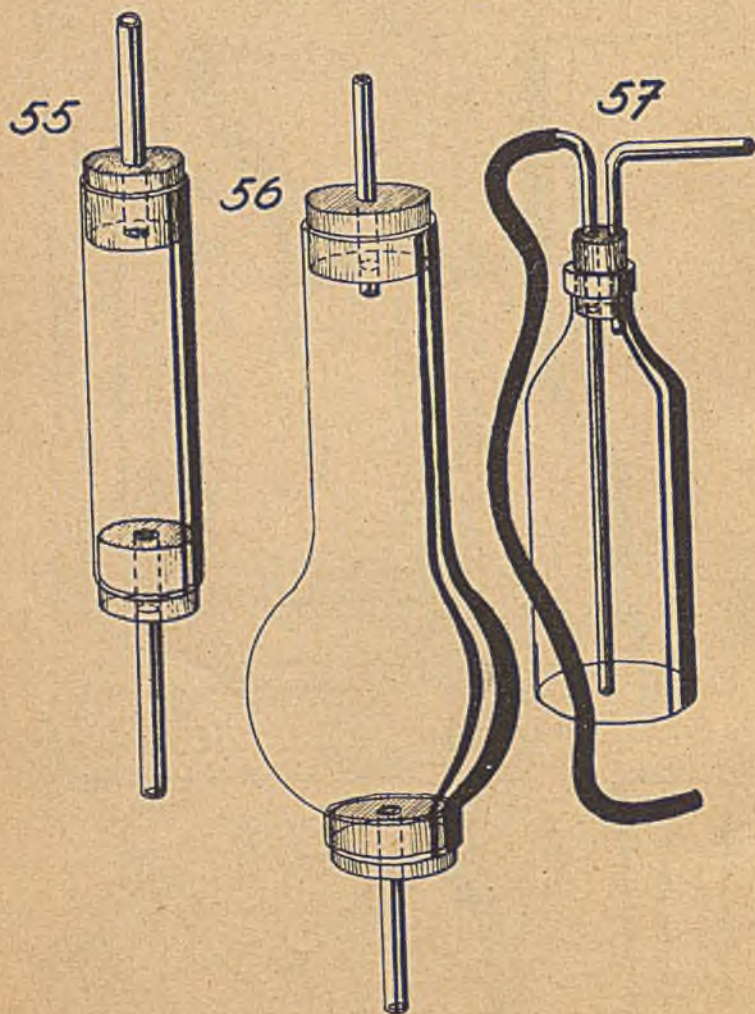
Lewary

Rozpylacze, oziębiacze

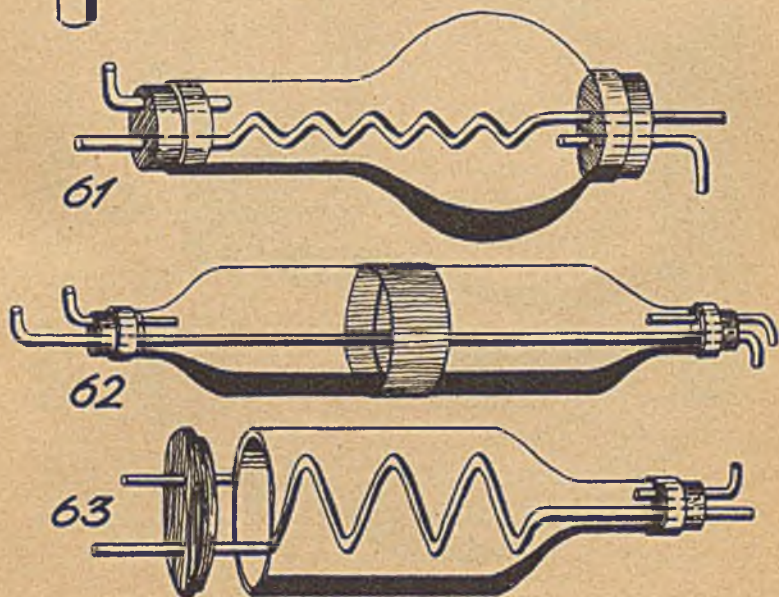
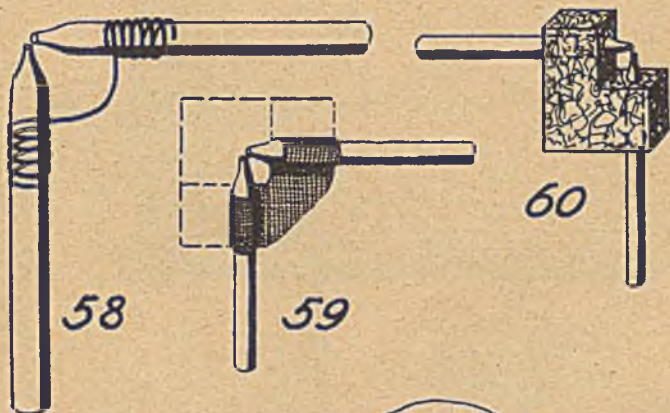

Butelka Lejdejska

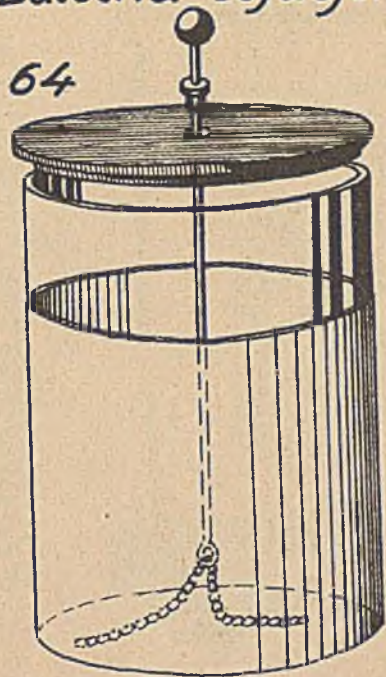

Elektroskop

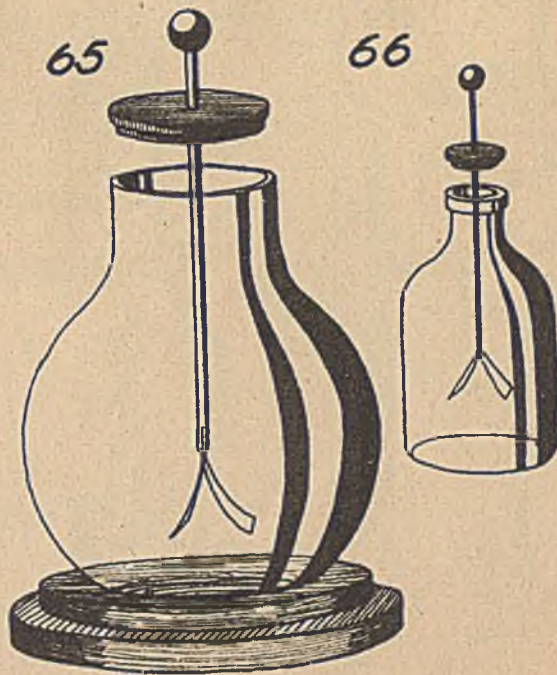

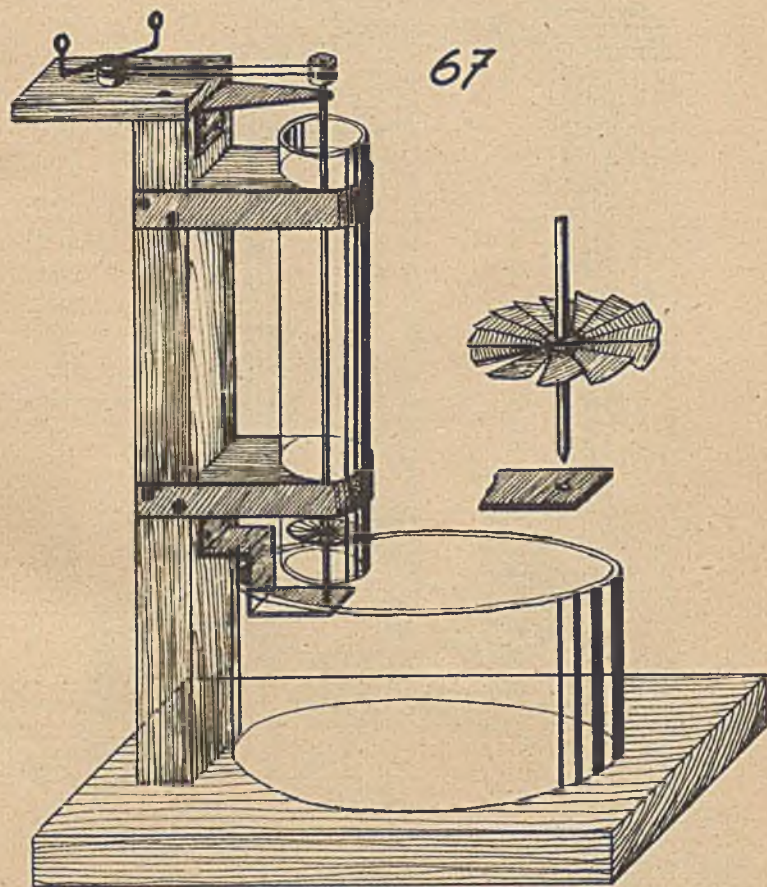
Turbina

Młyneczek Segnera

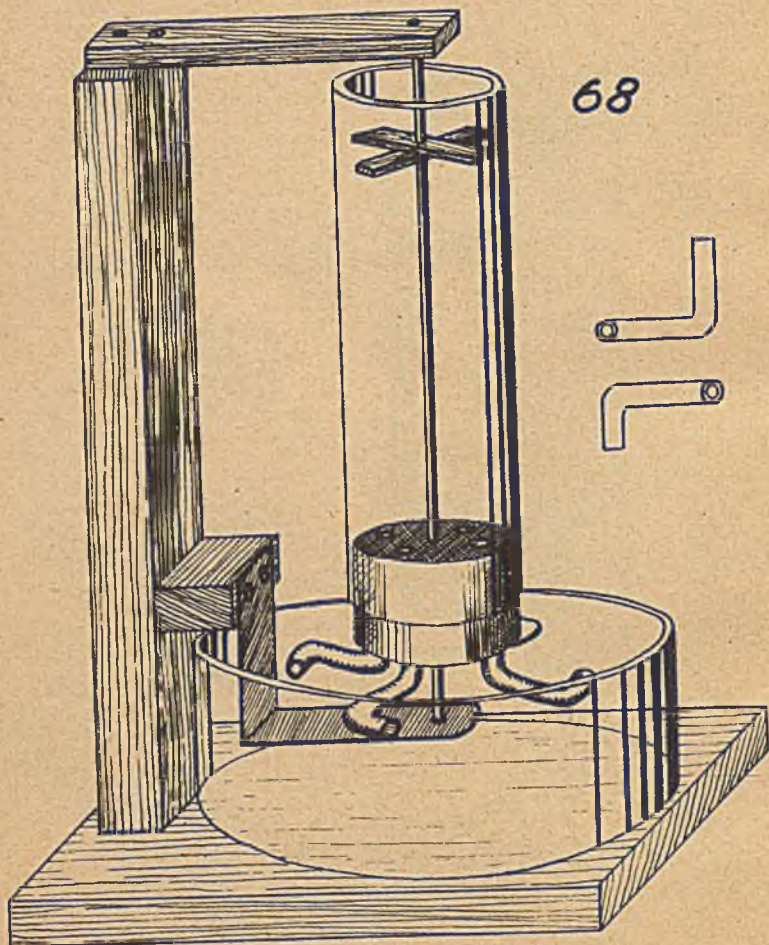

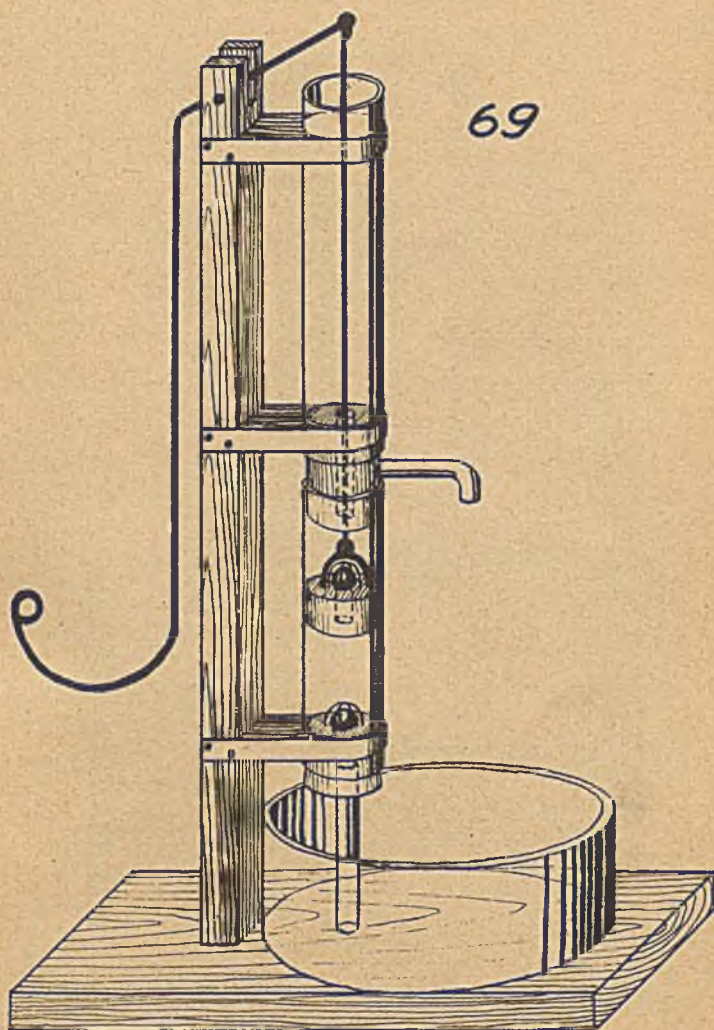
Studnia

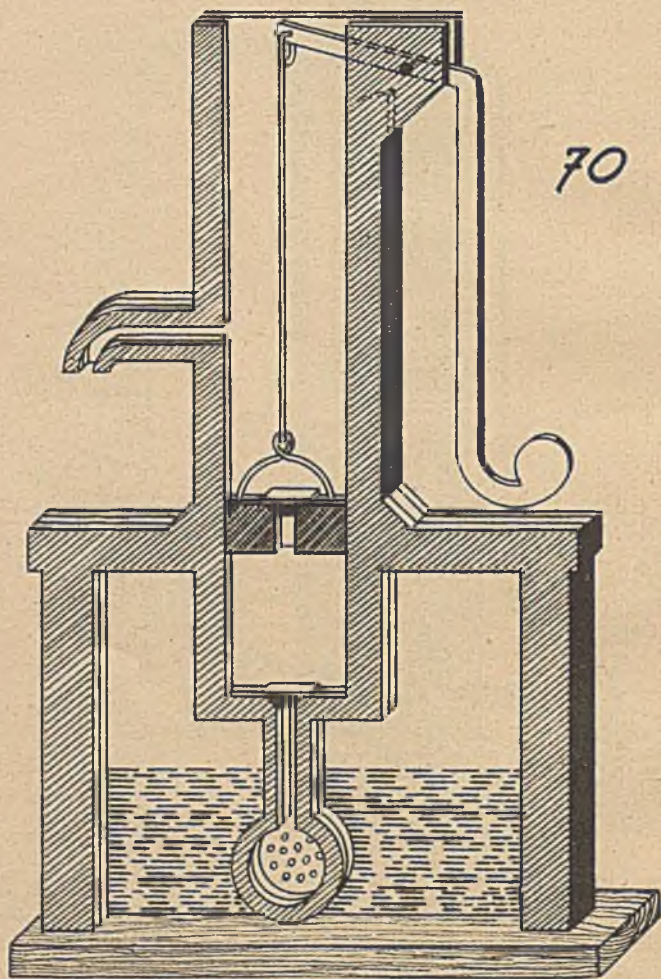
Studnia

Piec pokojowy

71

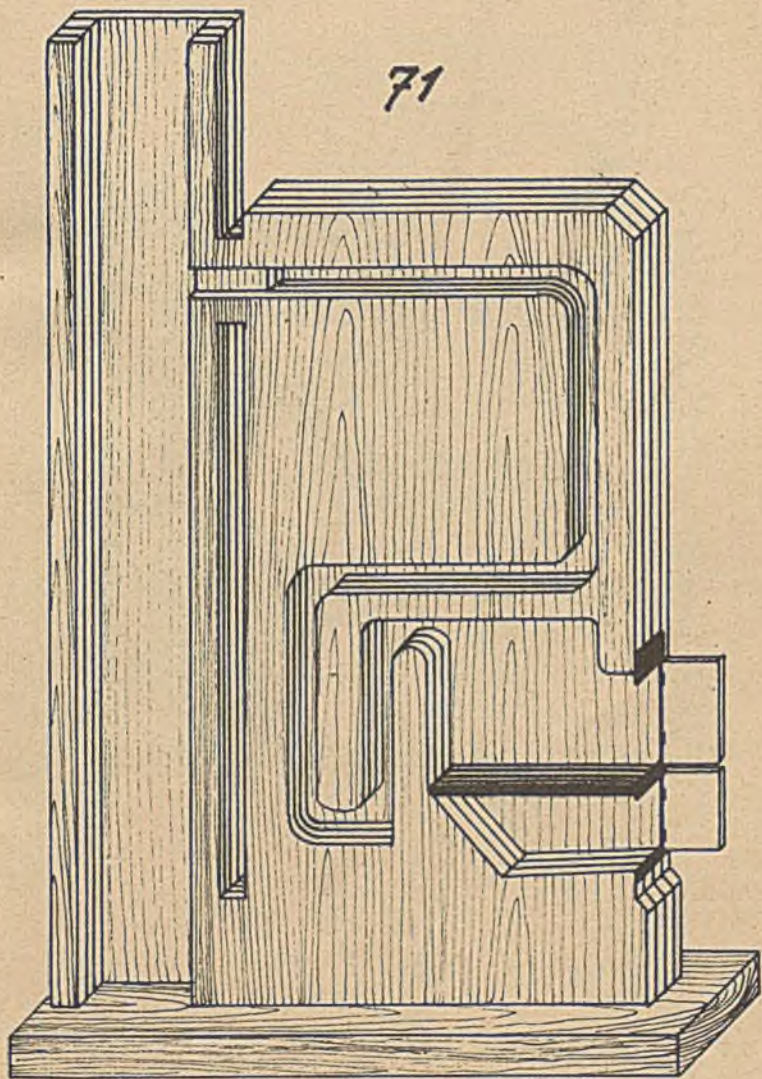

Sikawka strażacka

28

72

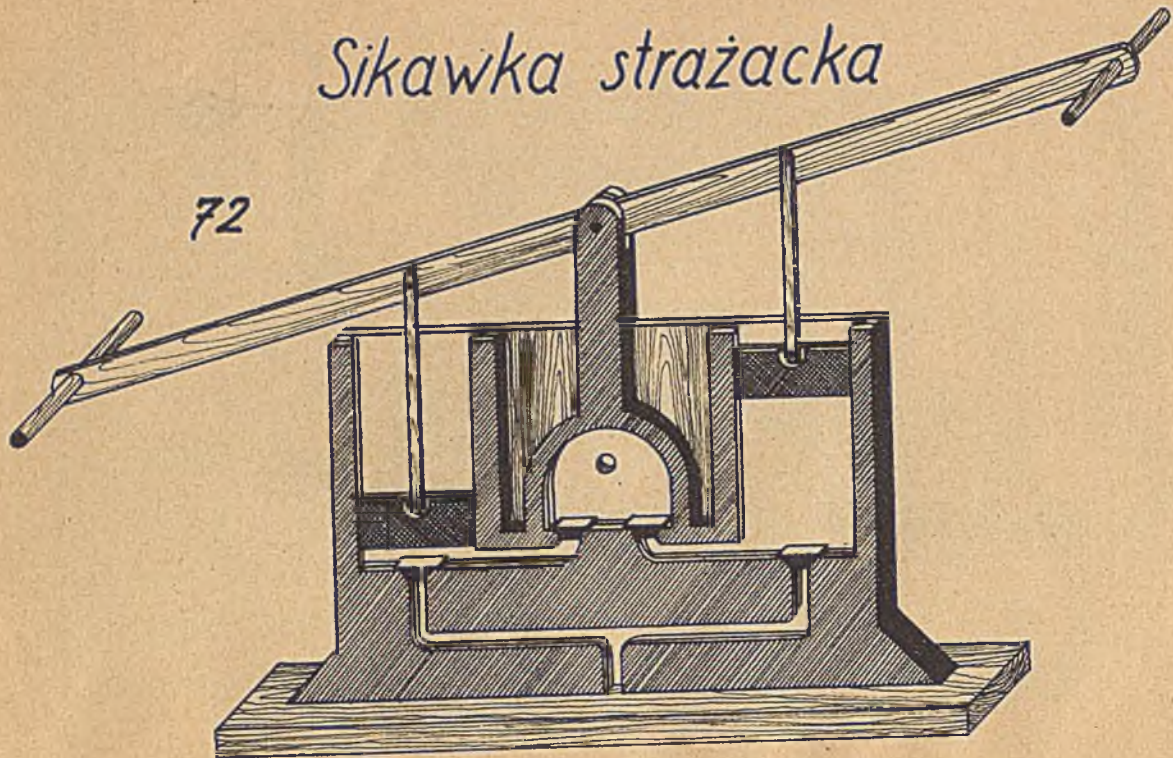

Przekrój cylindra parowego

73

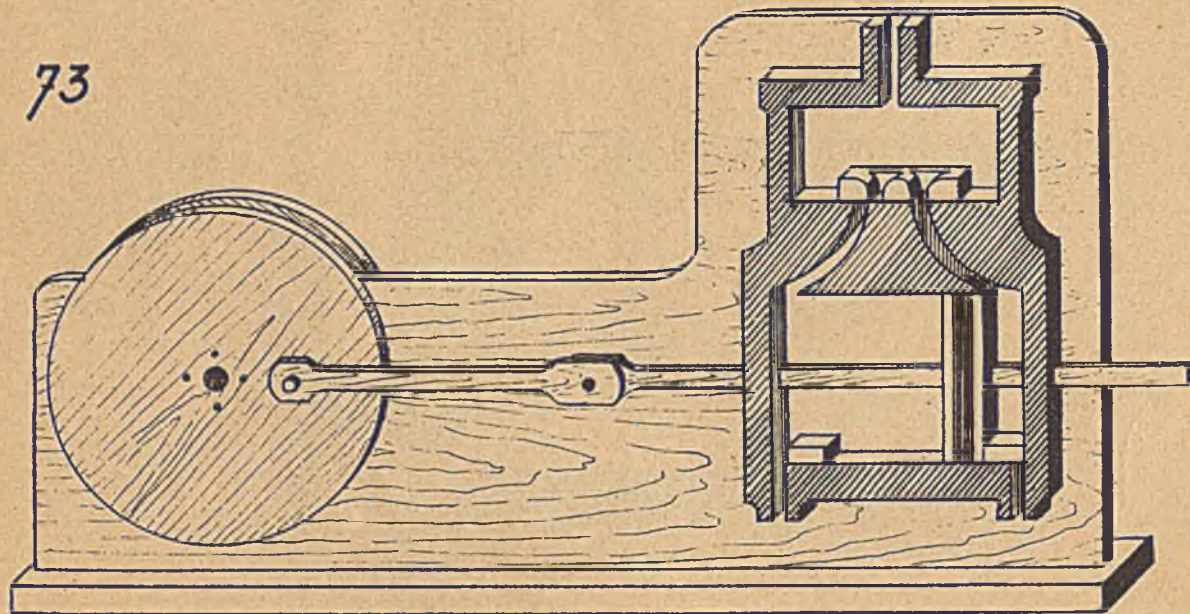

Statywy

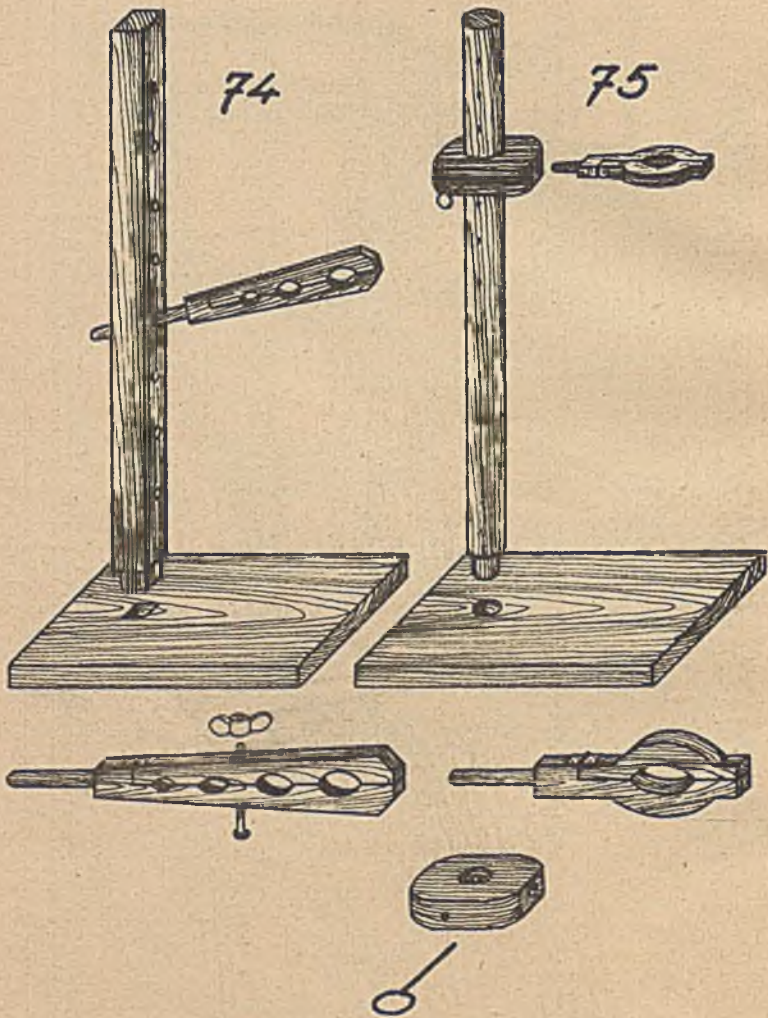

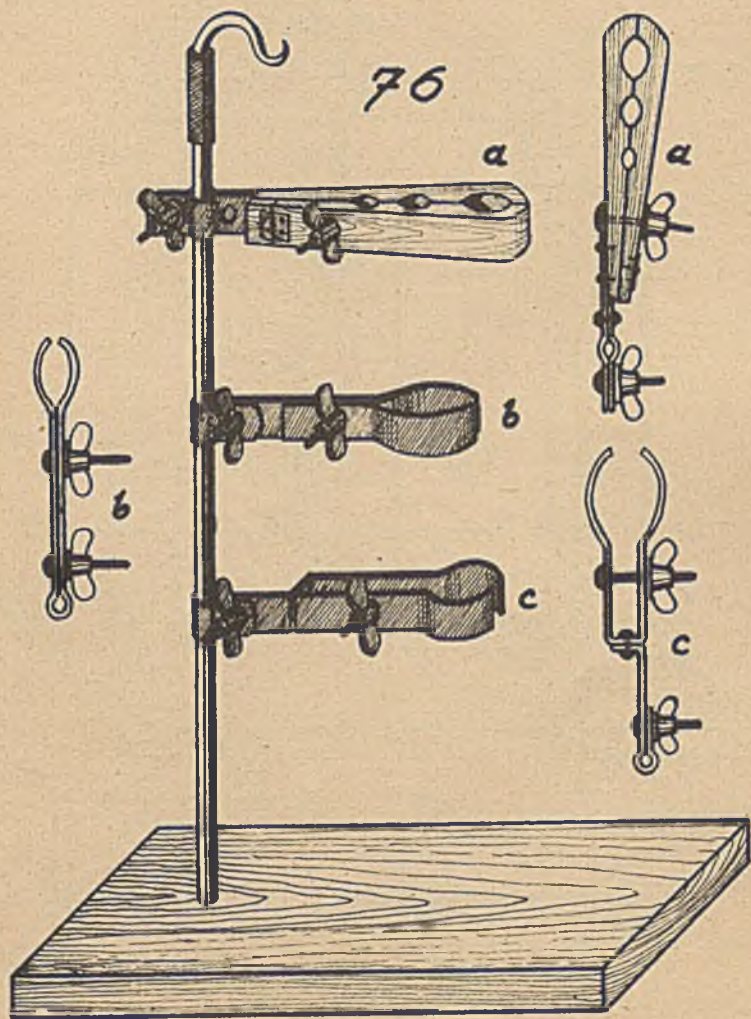
Statyw

Waga

77

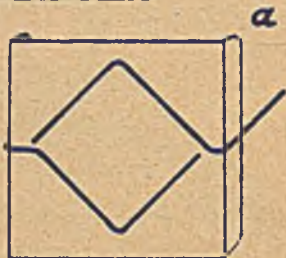
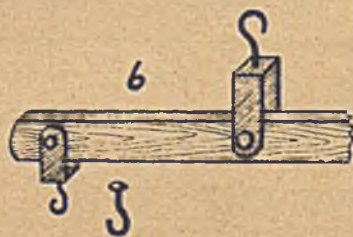
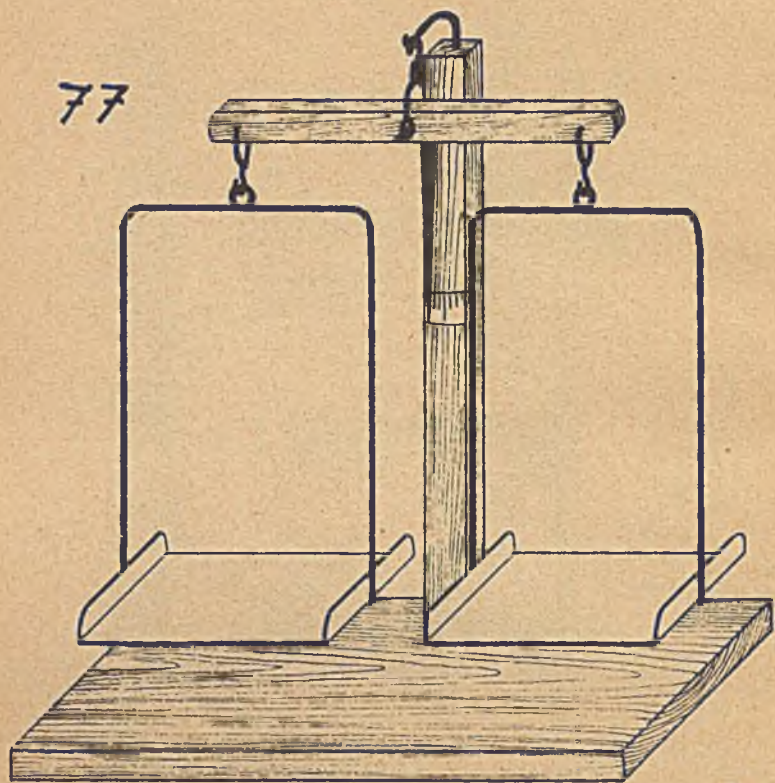

Wahadło

78

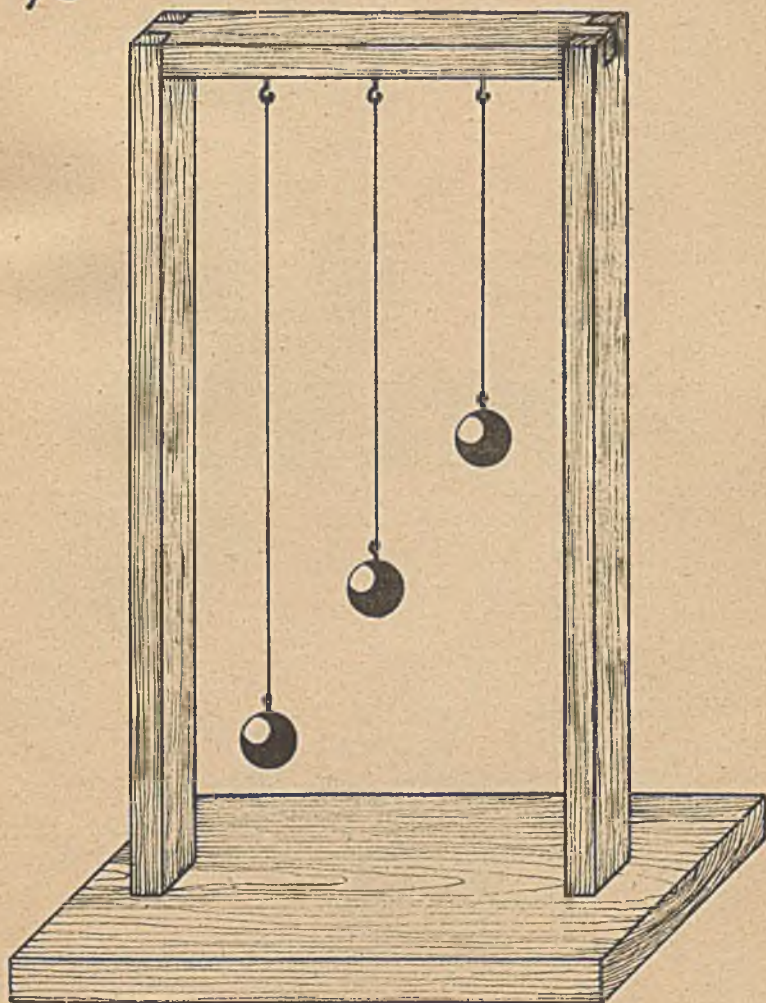

Dźwignia

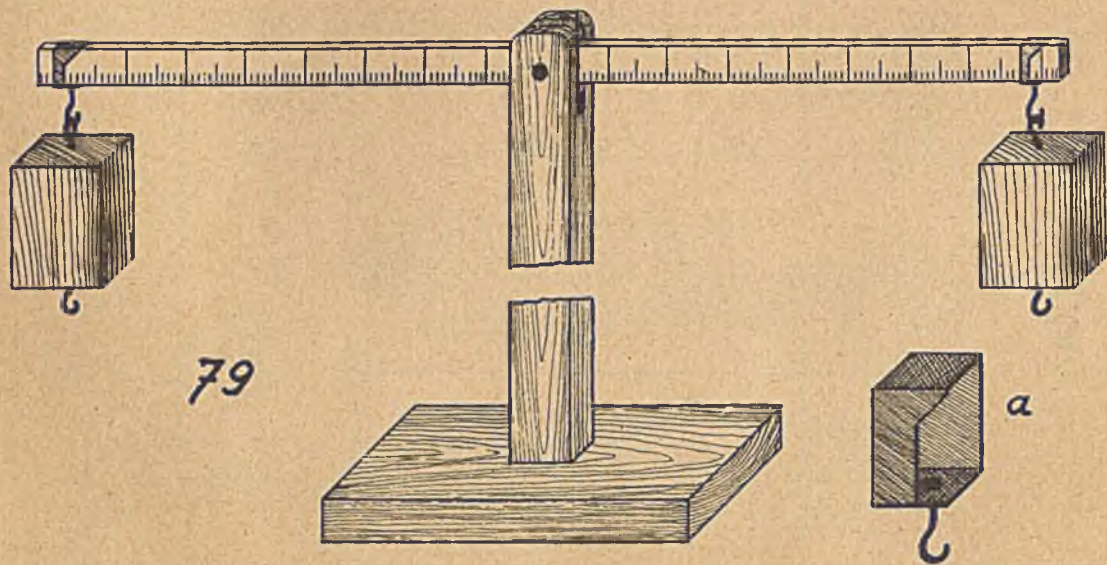

79

a

Równia pochyła

80

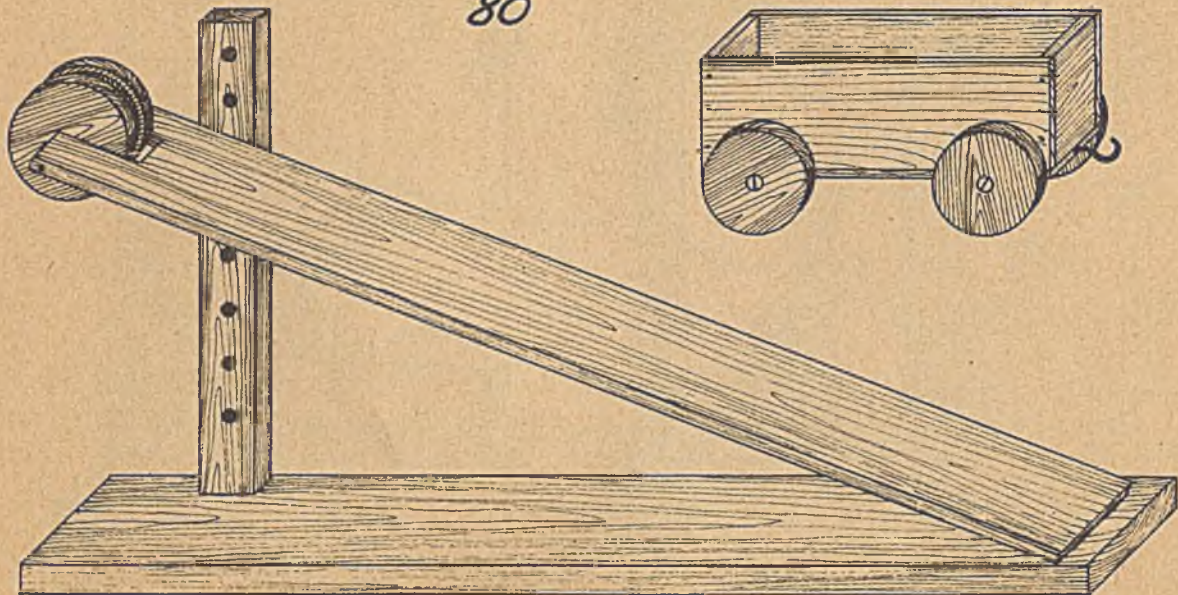
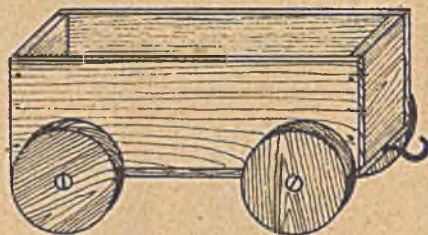

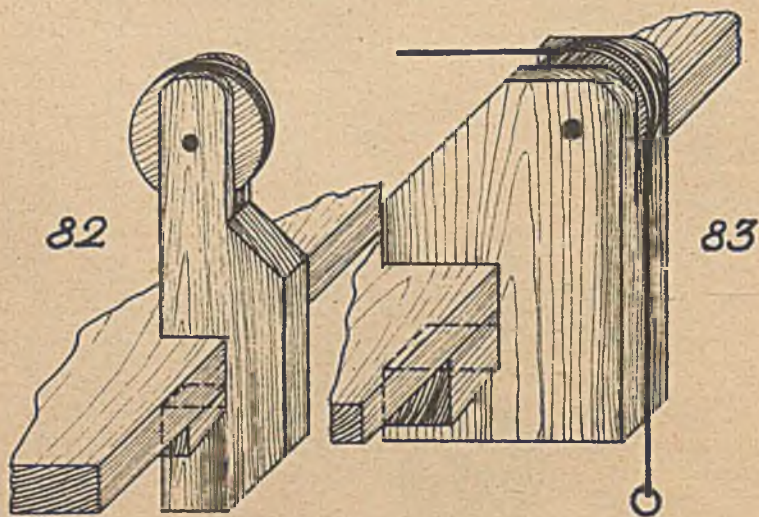
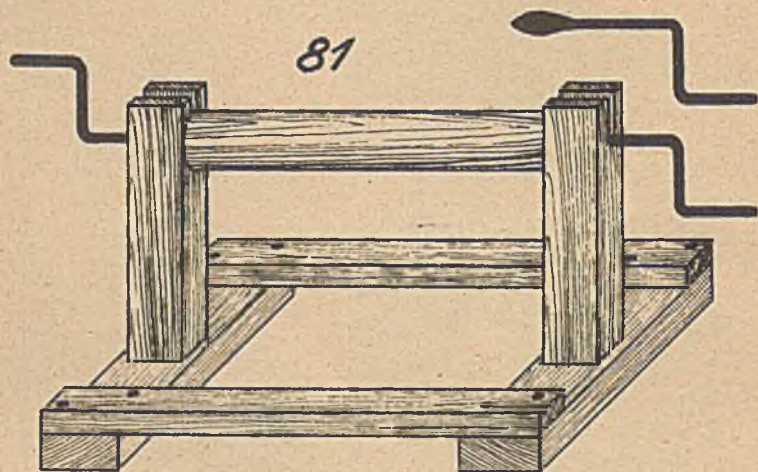
Kotowrót i bloki

Smigto

84

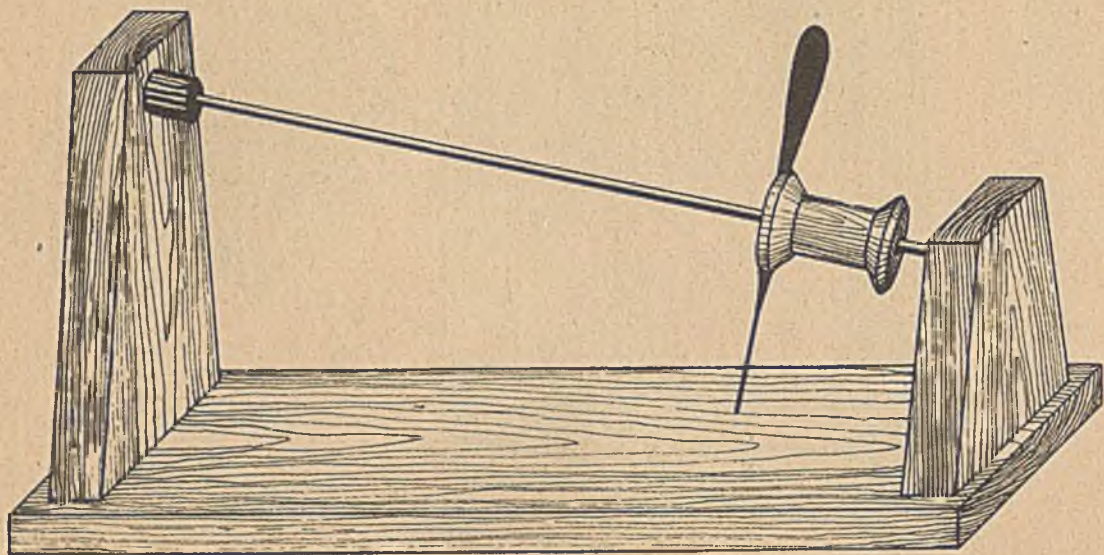

Koto wodne nasiębierne

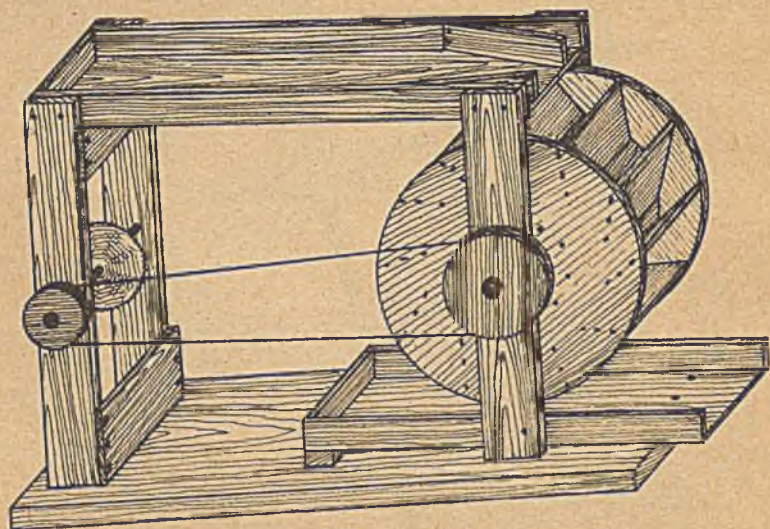

85

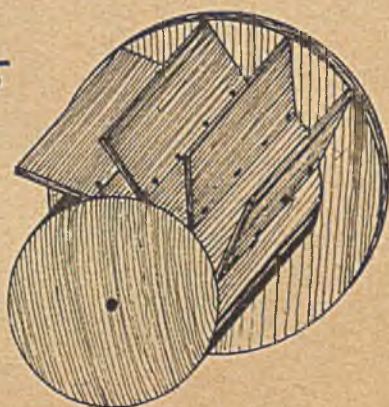

Wiatrak

86

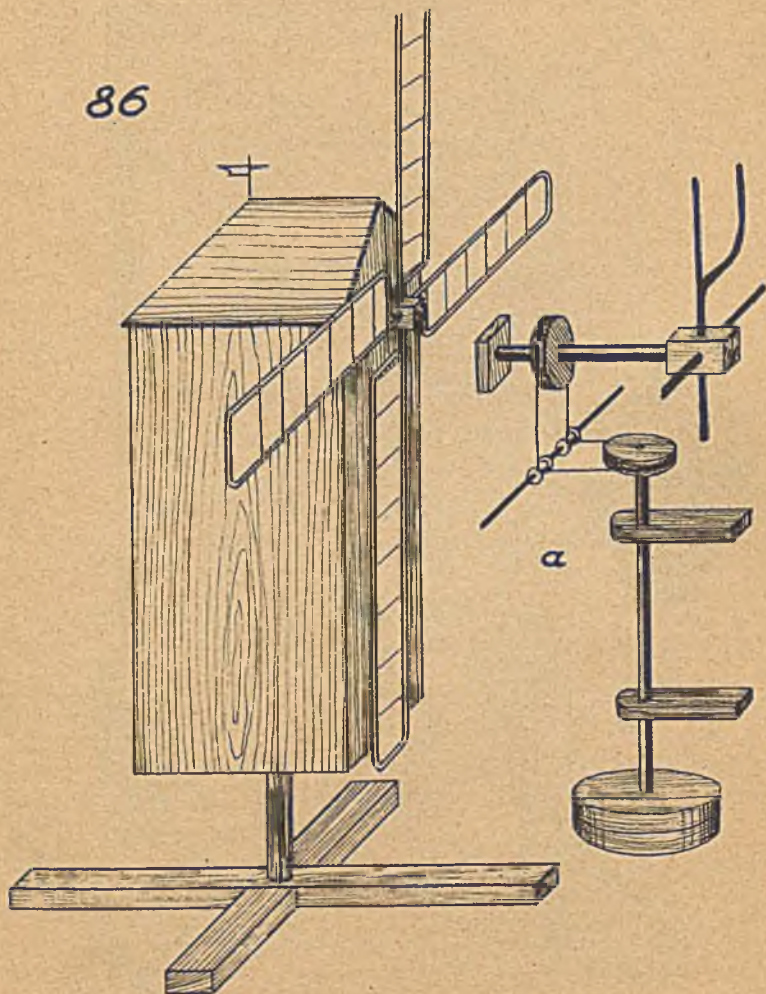

Zegar wahadłowy

87

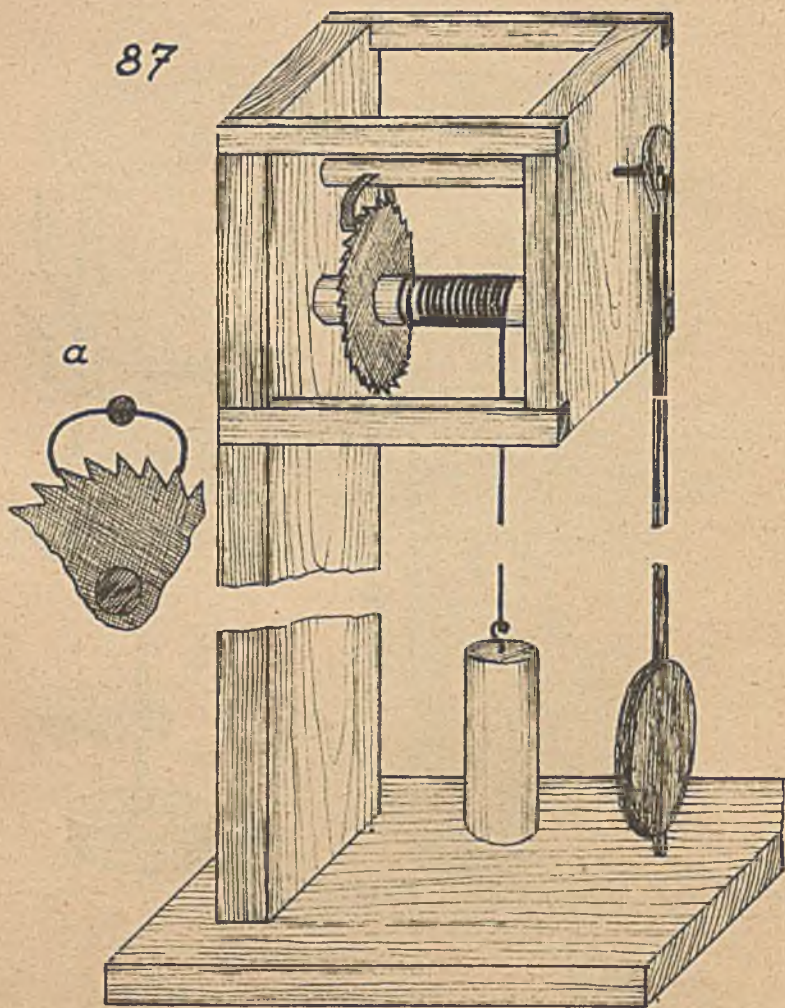

Ekrany

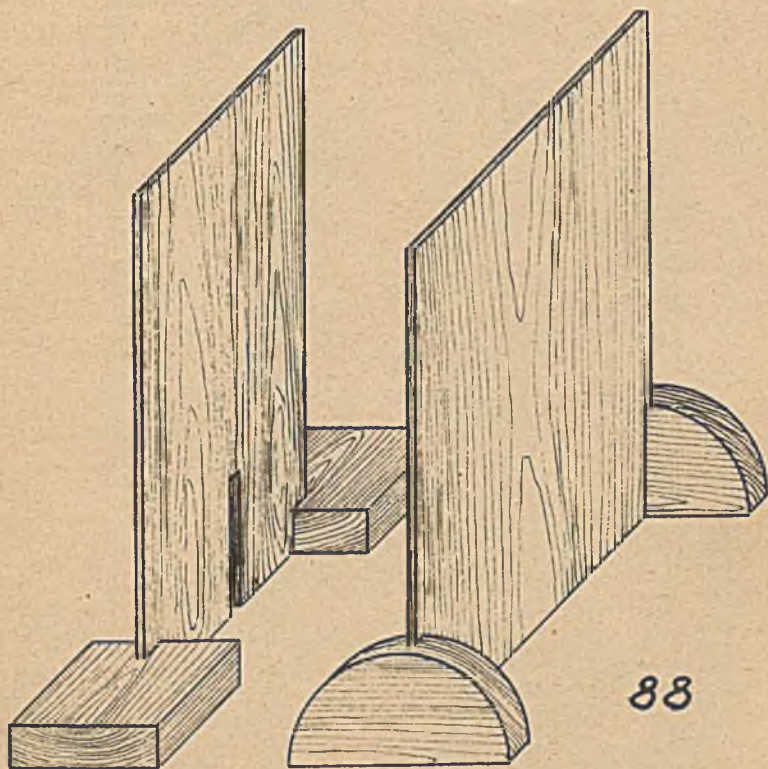

88



Peryskop

89

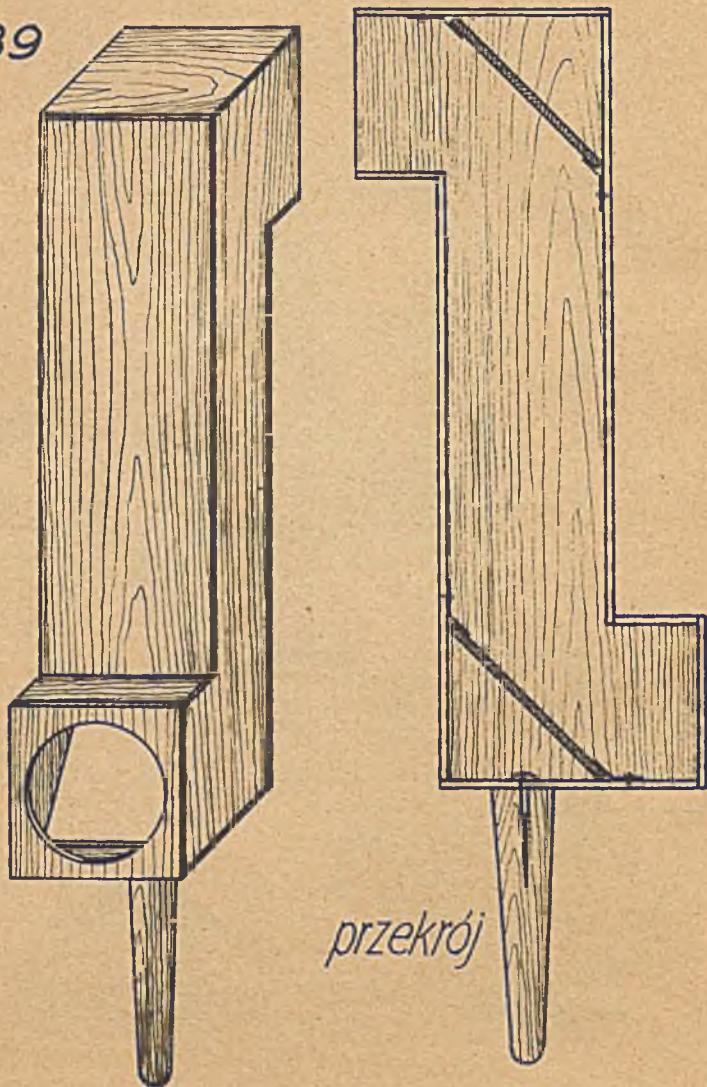

Ciemnie optyczne

90

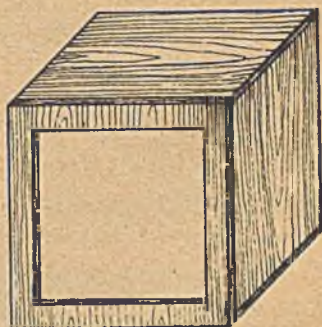
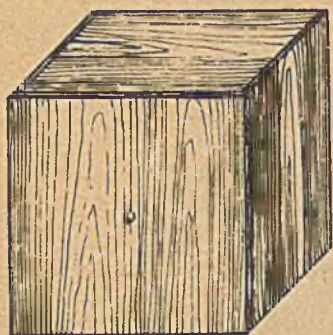

91

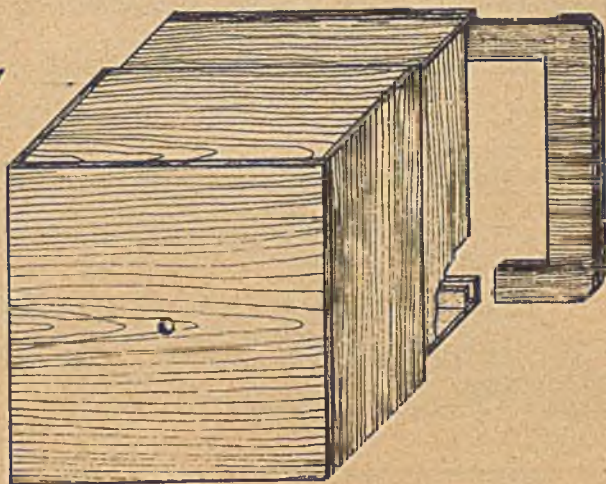

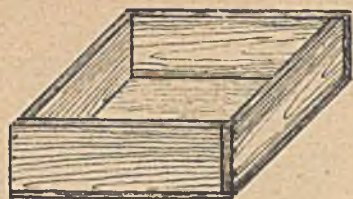
Pudełka i skrzynki na zbiory

92

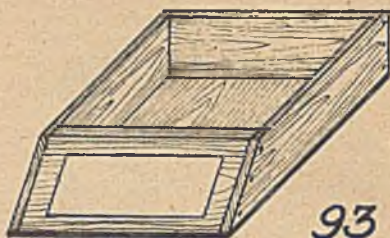

93



94

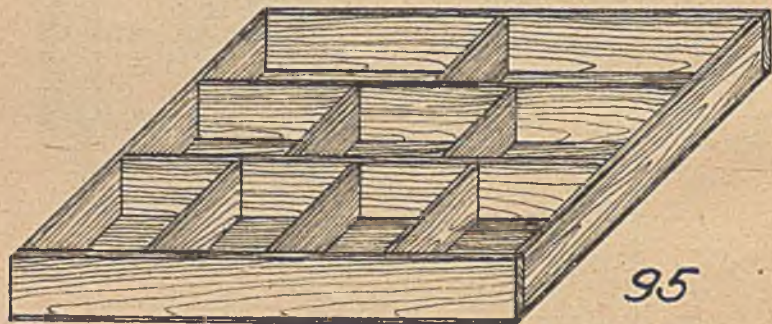

95

Igły magnetyczne

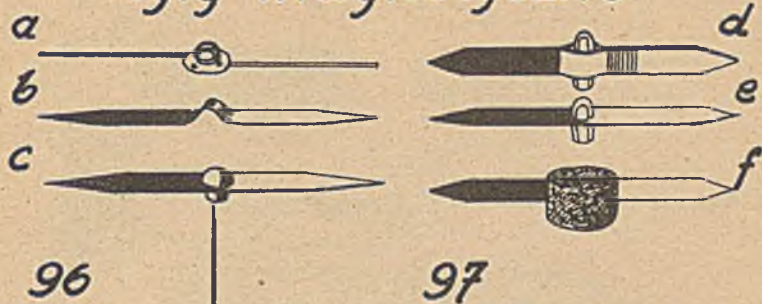

96



97

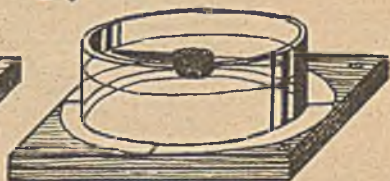

98

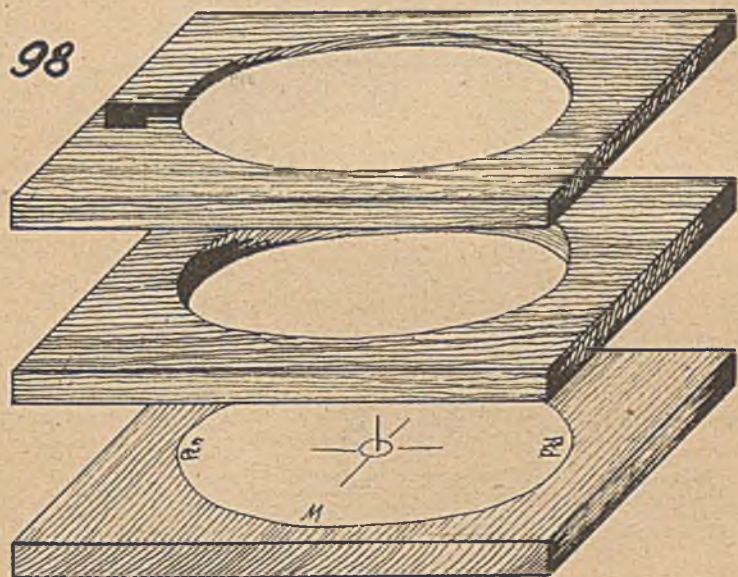

Elektromagnes

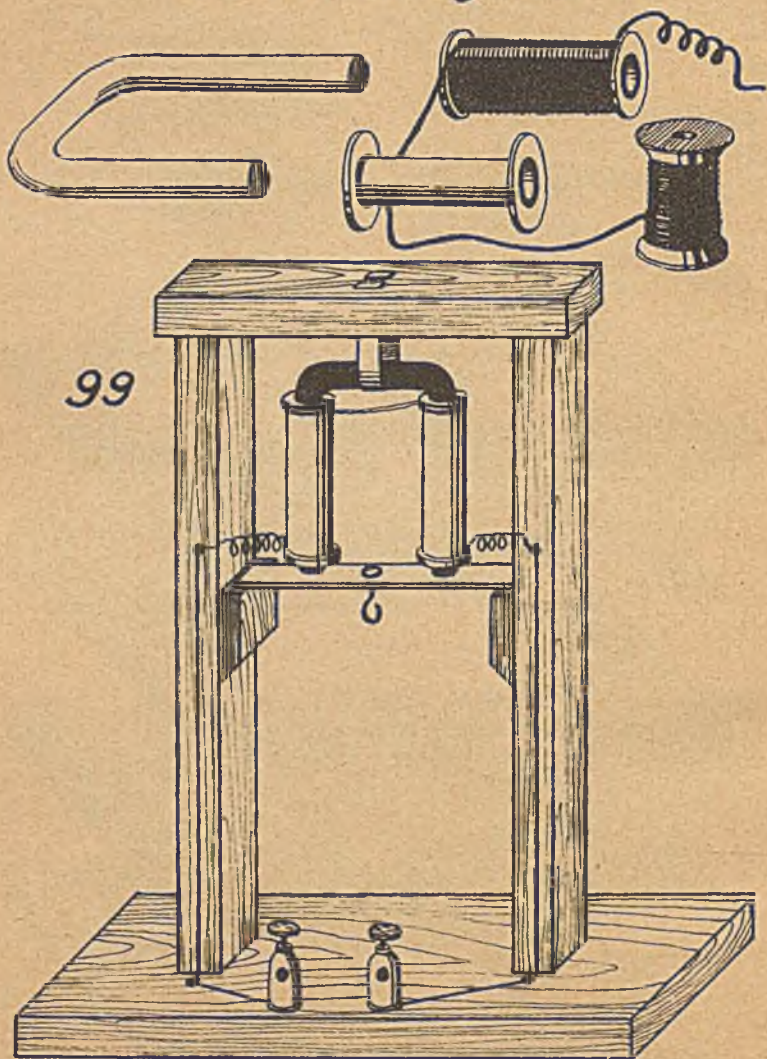

Elektromagnes - brzęczyk

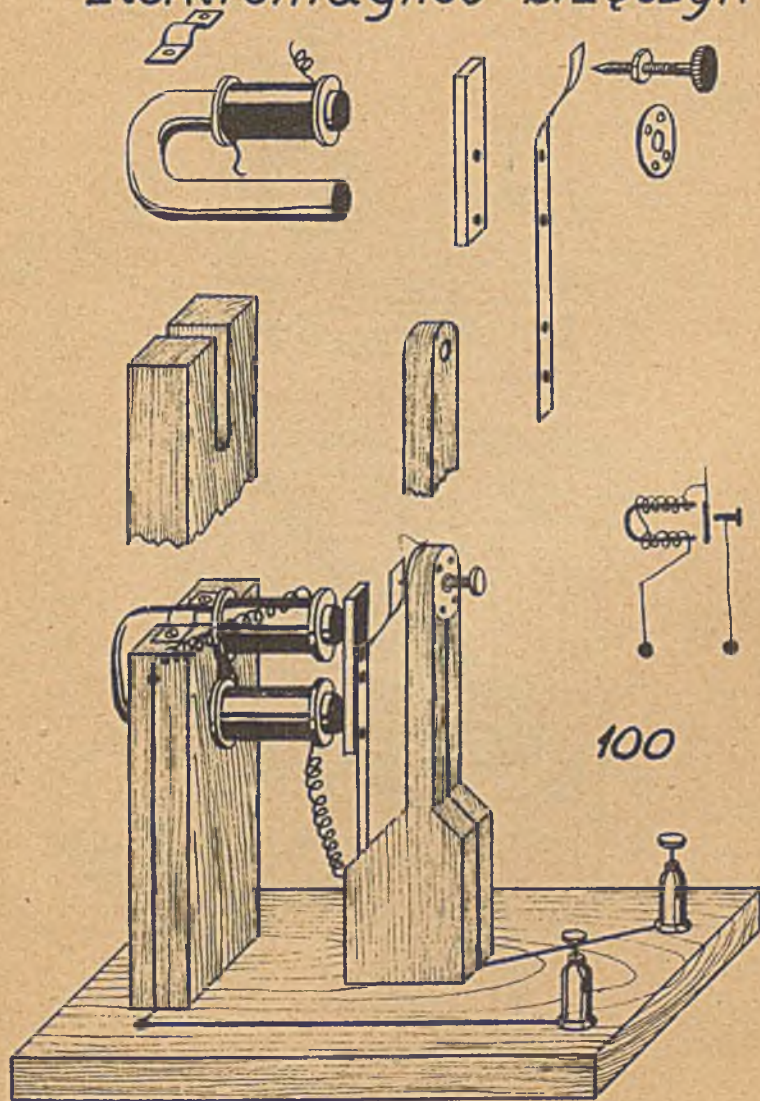

Dzwonek elektryczny

101

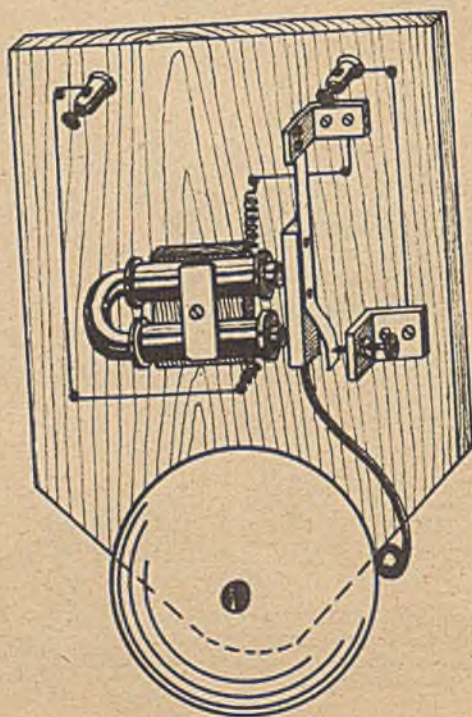
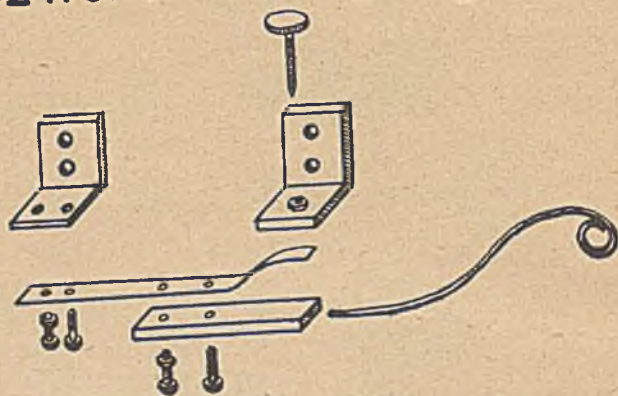

Obwód prądu

102

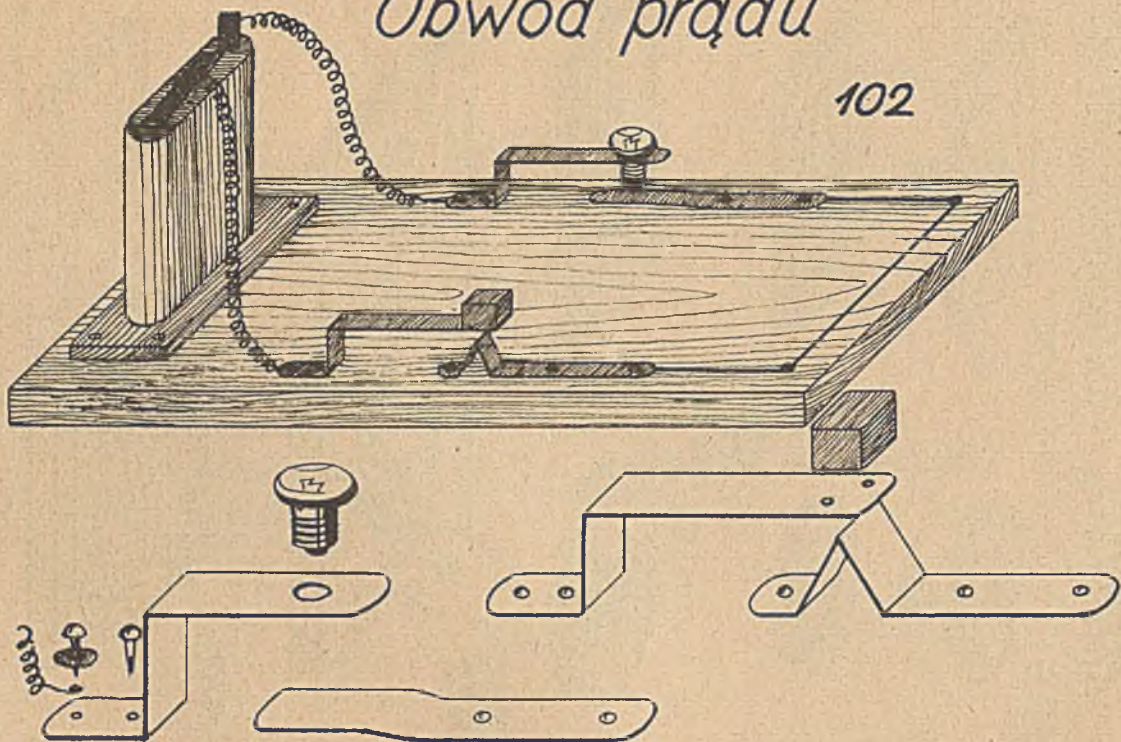

Przyciski, rozdzielnik, klucz.

103



104



105



106



Motorek elektryczny

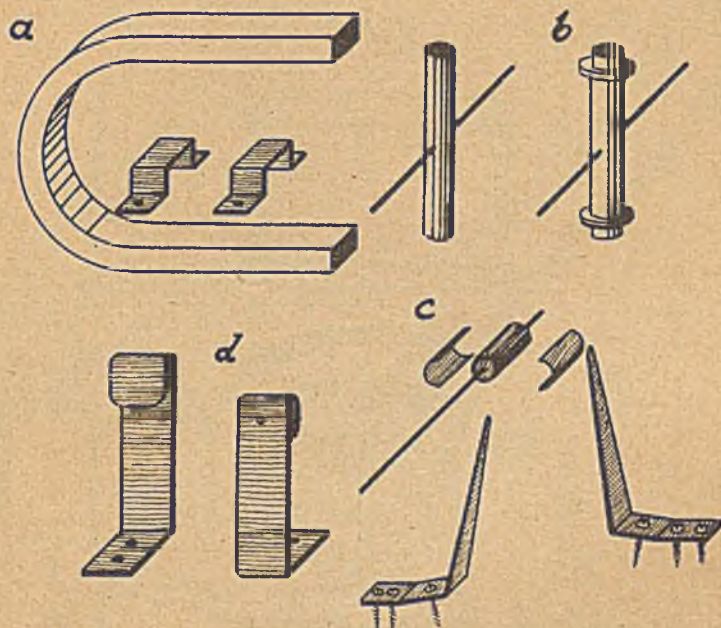

107

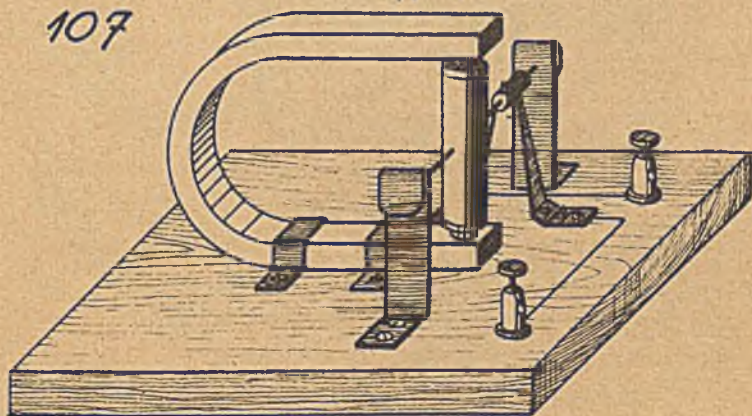

Galwanoskop

108

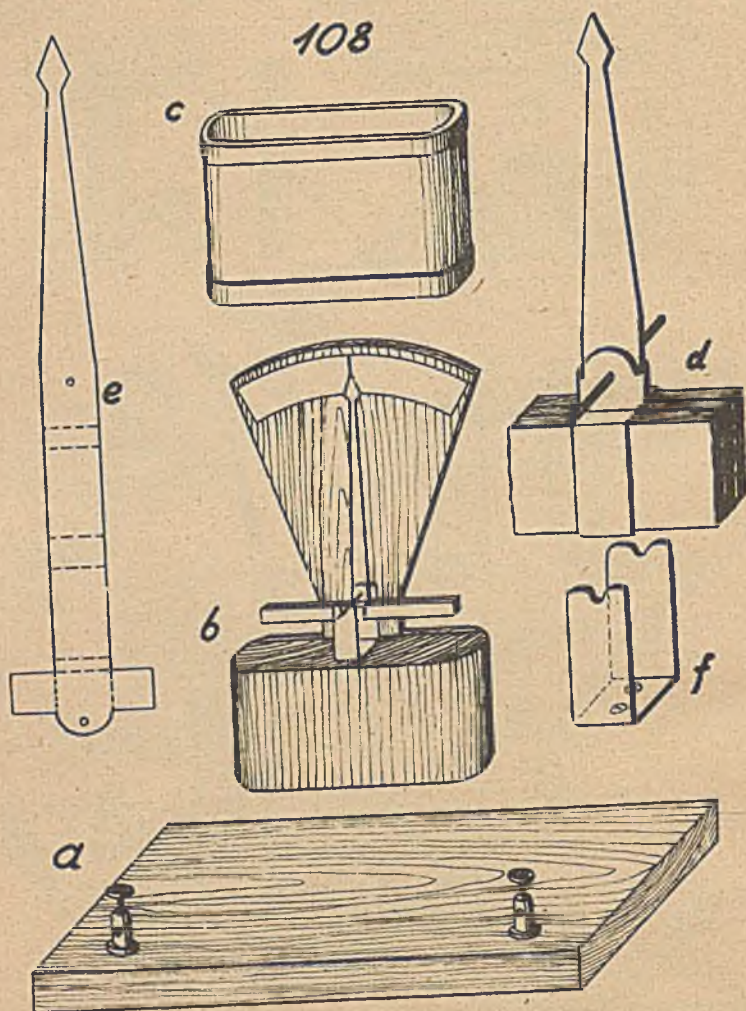

Detektor

109

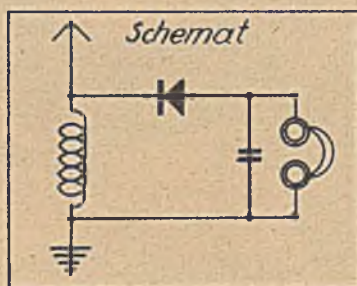
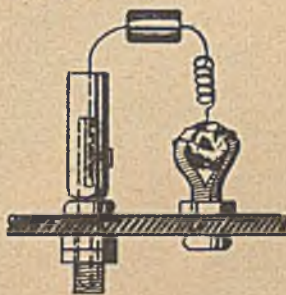
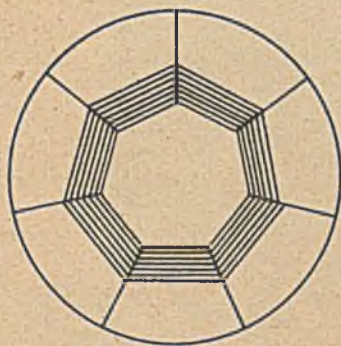
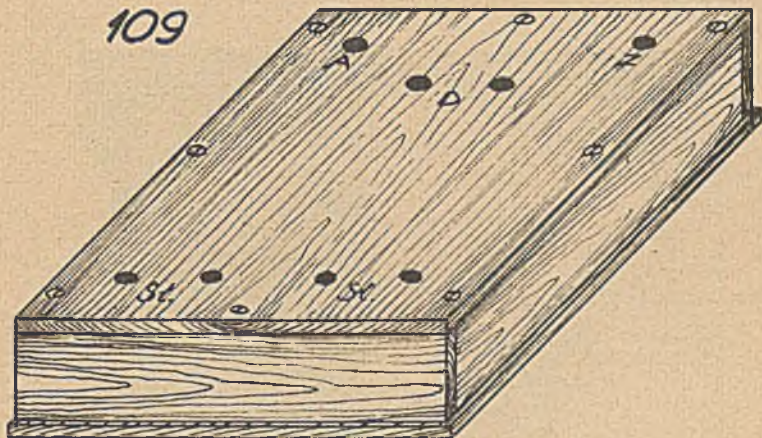

Detektor

110

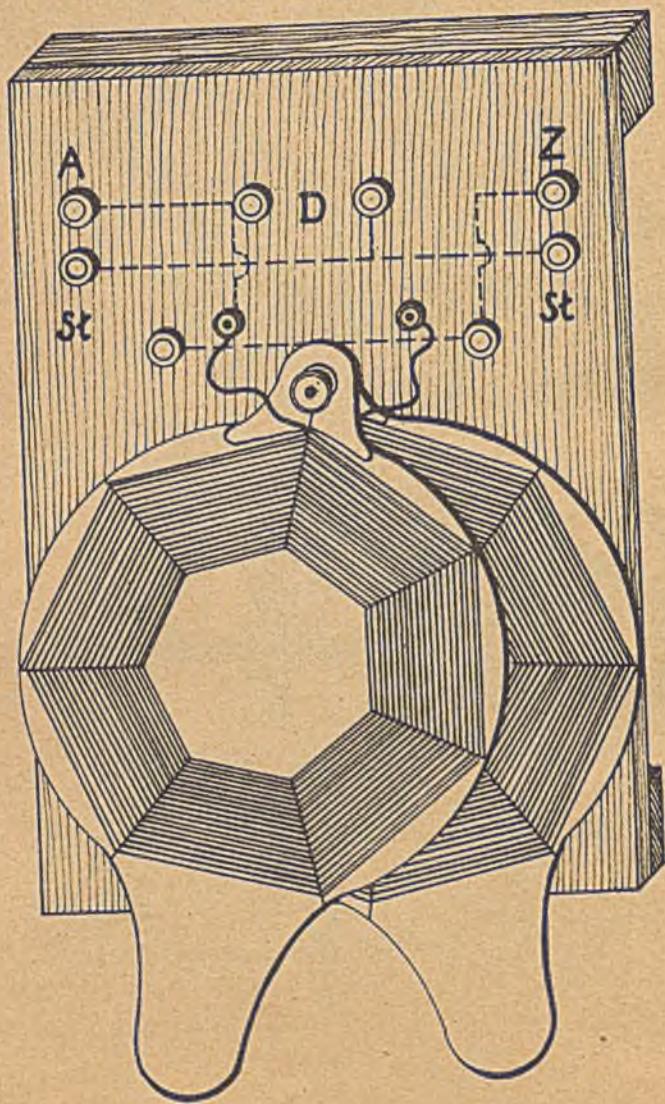

Detektor suwakowy

111

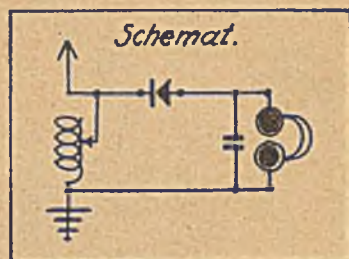
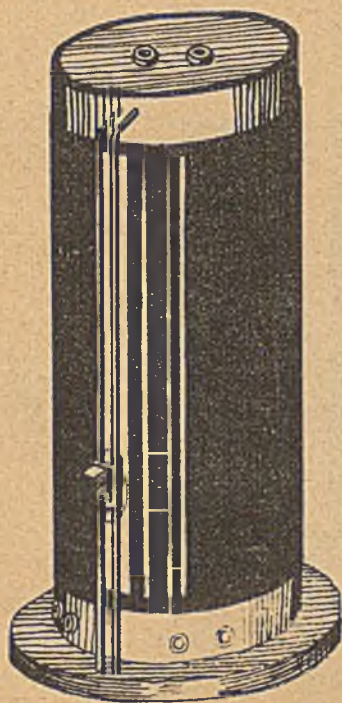

Wiatrowskaz

112

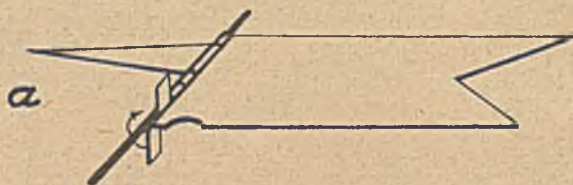
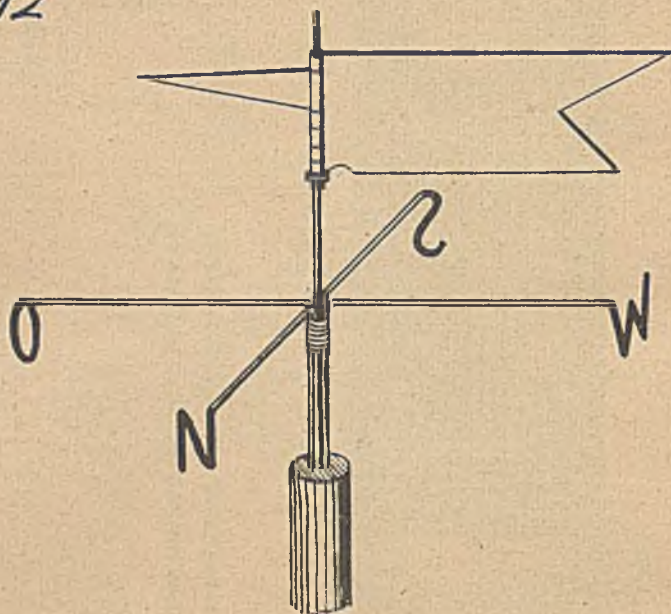

Poziomica

113

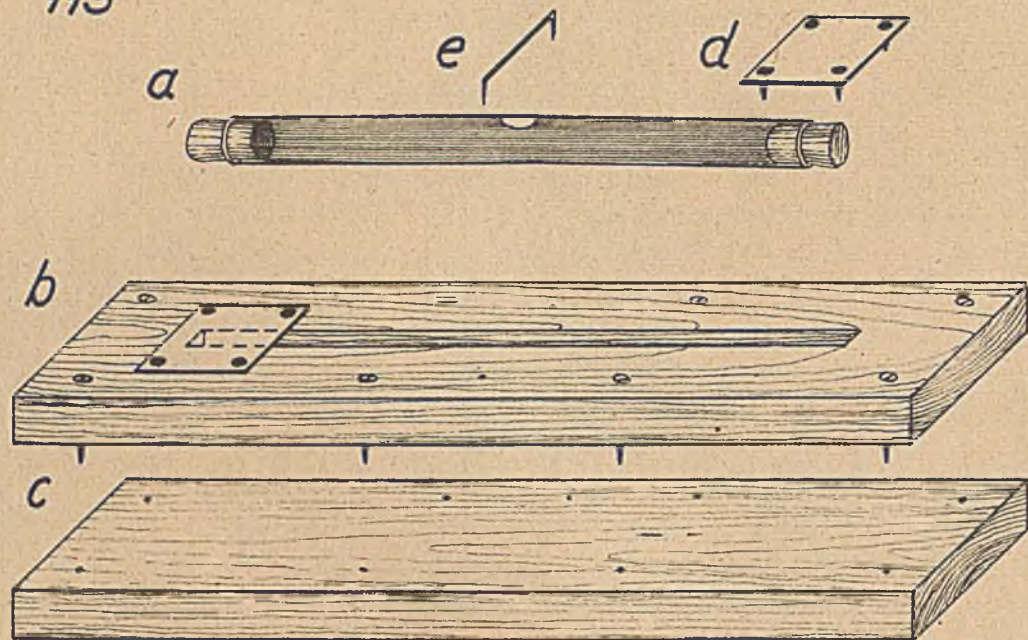

Zegary słoneczne

114

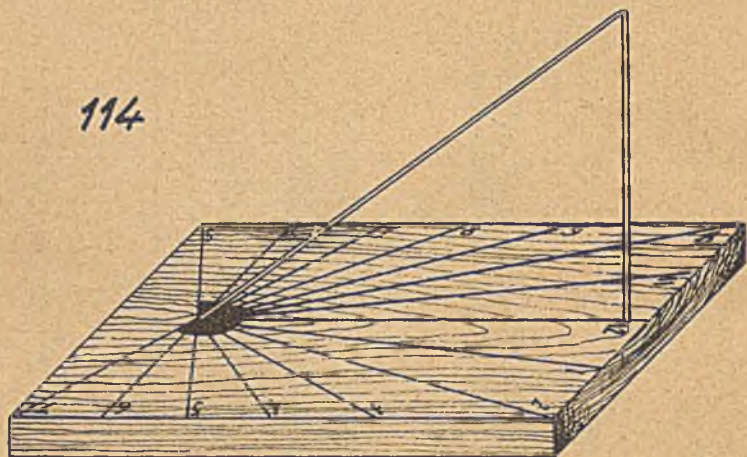

115

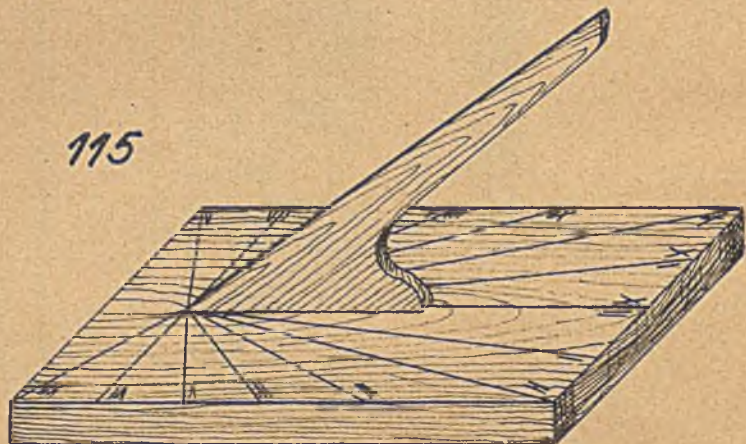

Deszczomierze

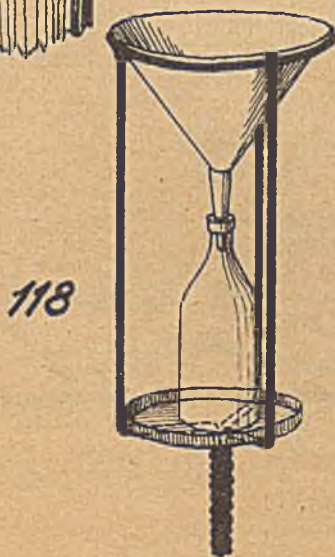
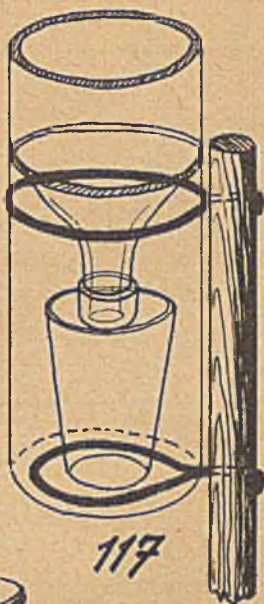
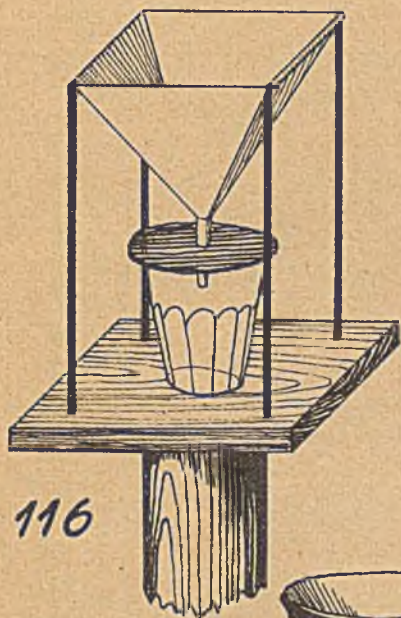

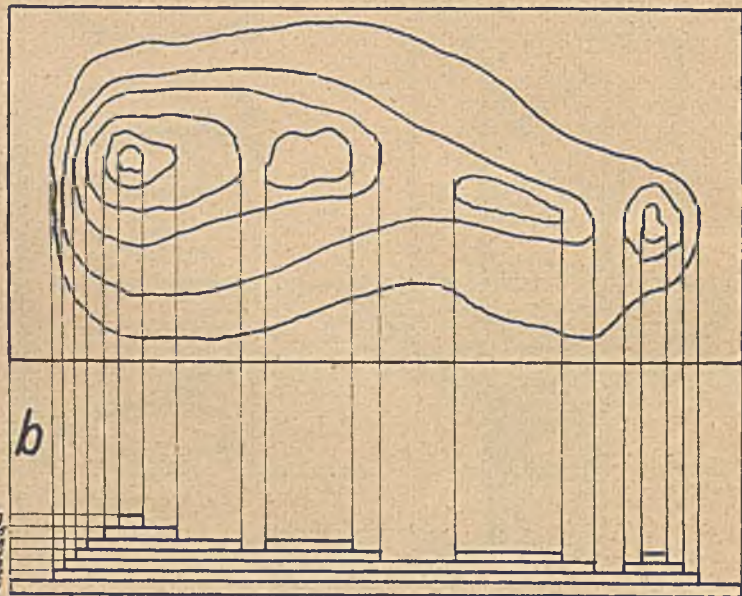
*Warstwie**a*

119

c

Warstwie

120

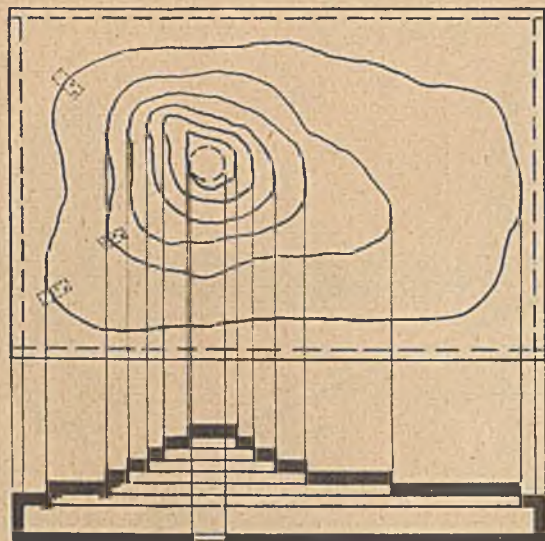

121

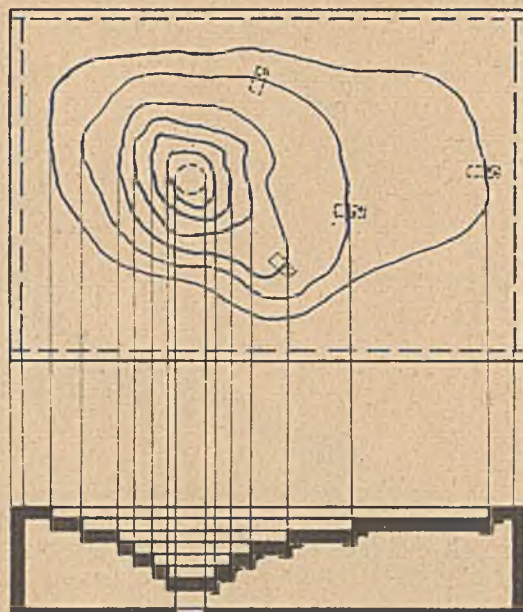

Wykazanie kulistości ziemi

122

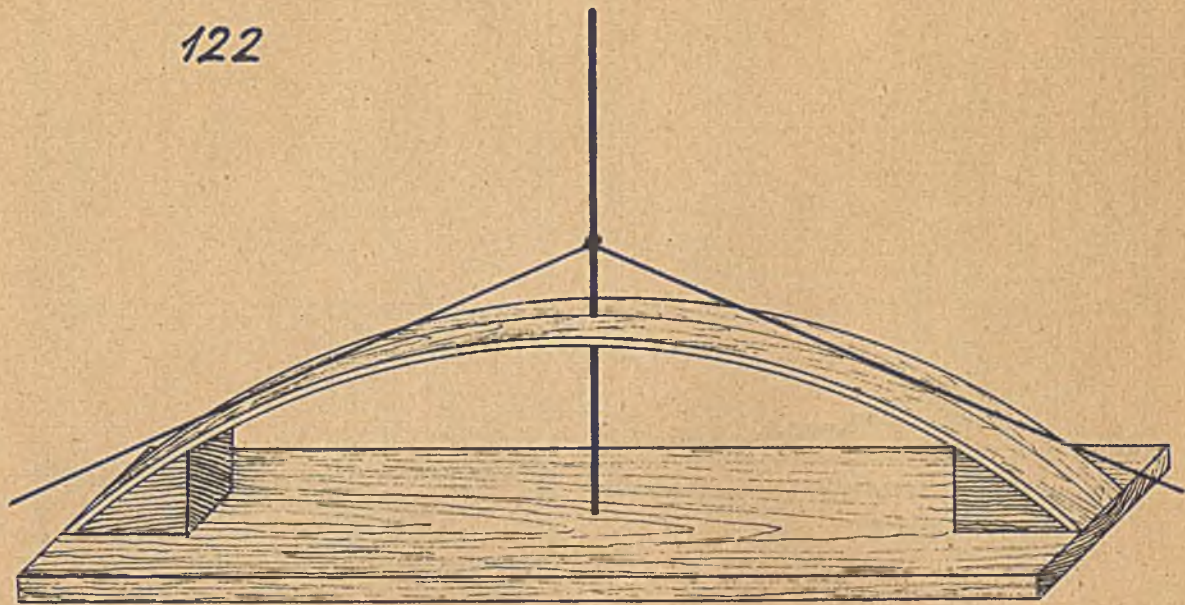

Wykazanie kulistości ziemi

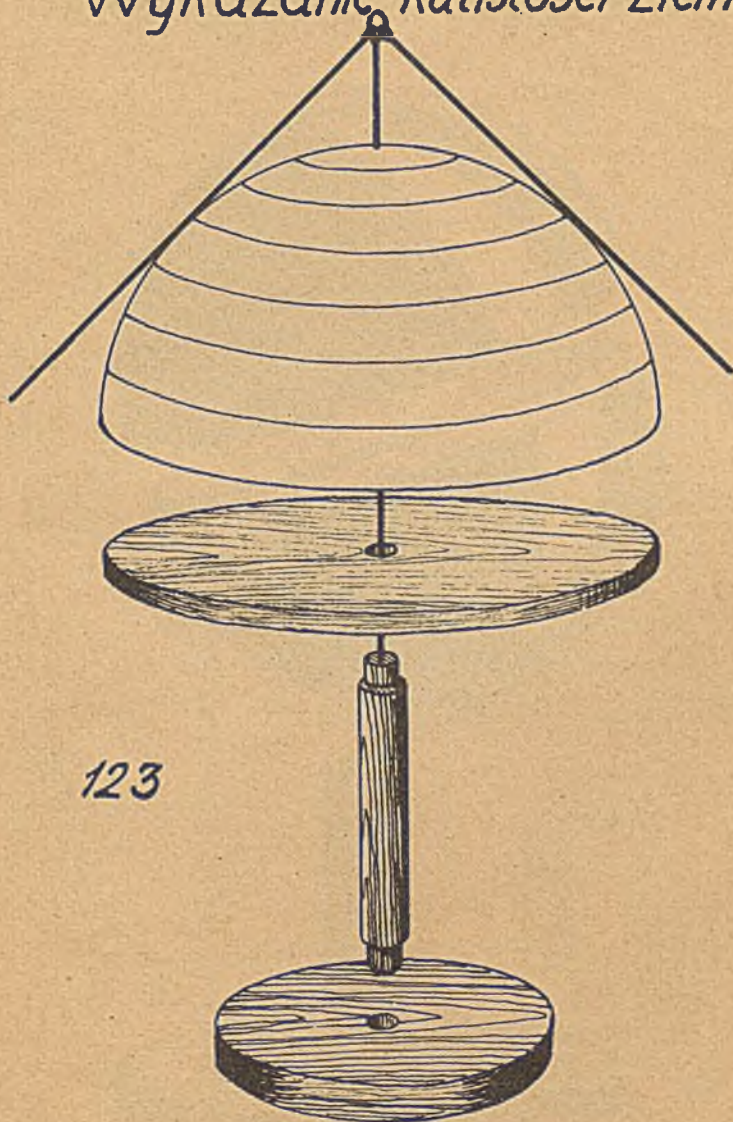

123

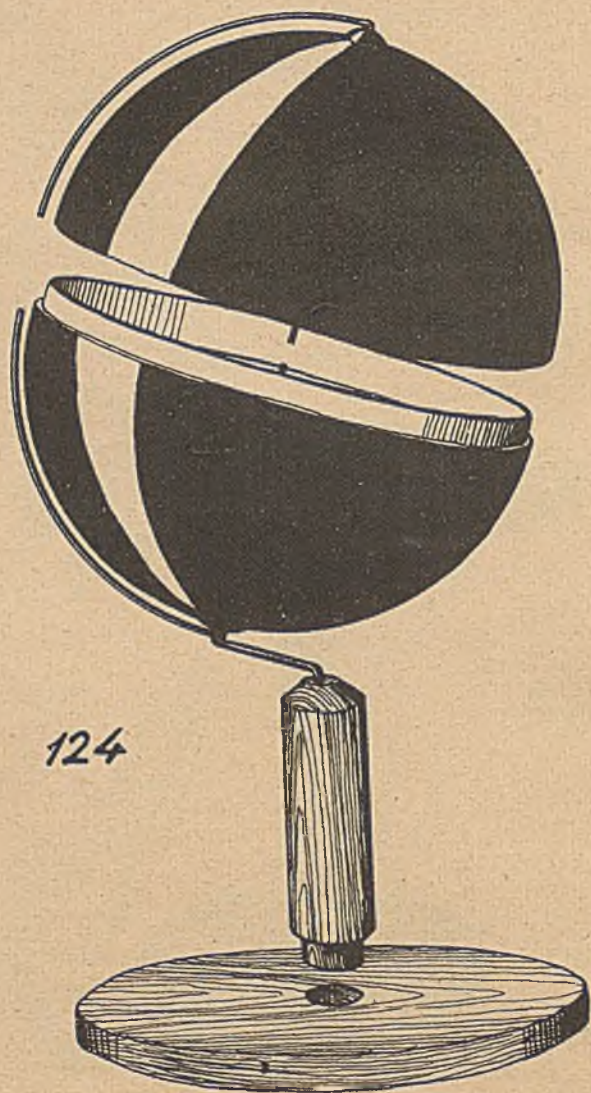
Globus indukcyjny

Gnomon, kątomierz, klinometr

125

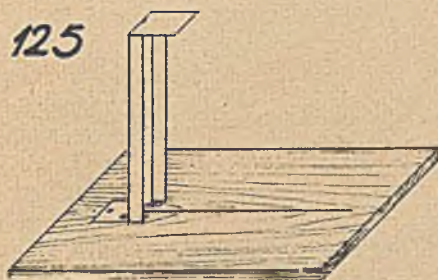

126

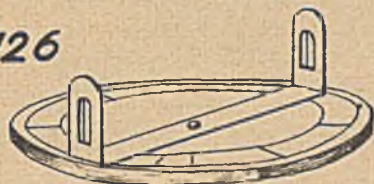

127

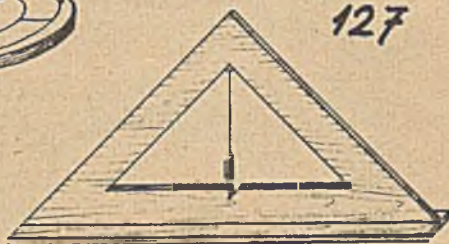

128

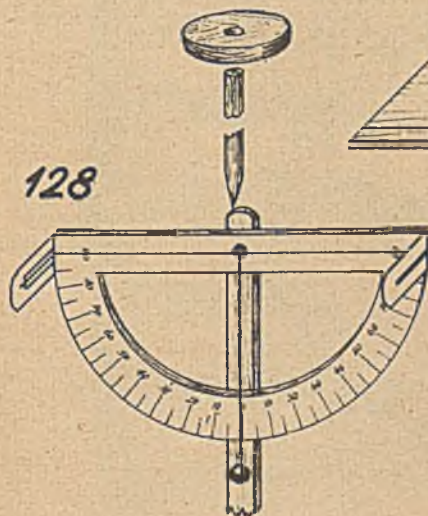

a

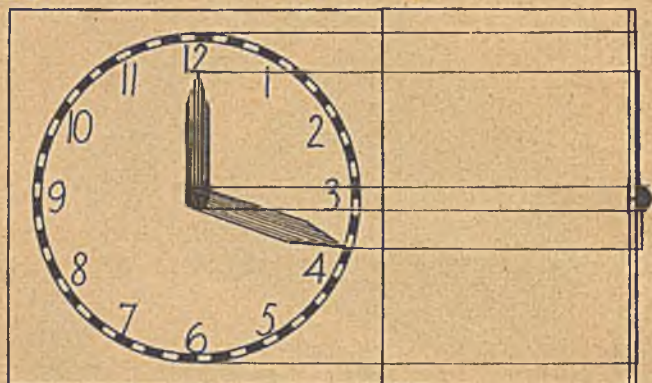

129 *Zegary*

130

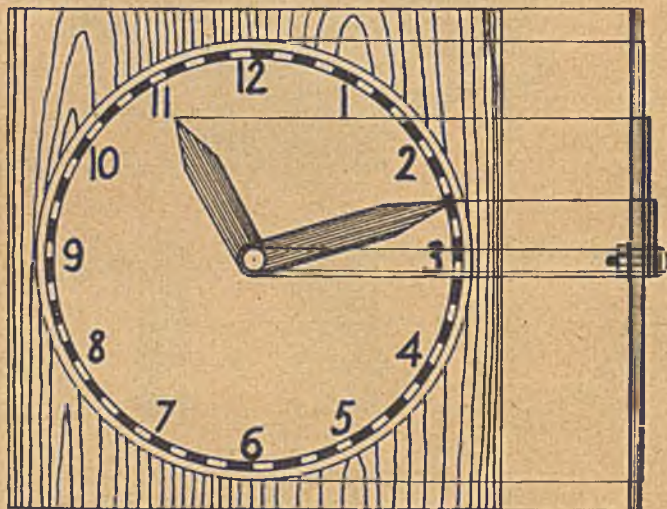

Liczydła

131



132

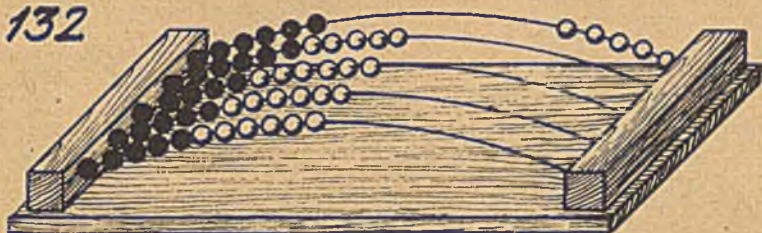

133

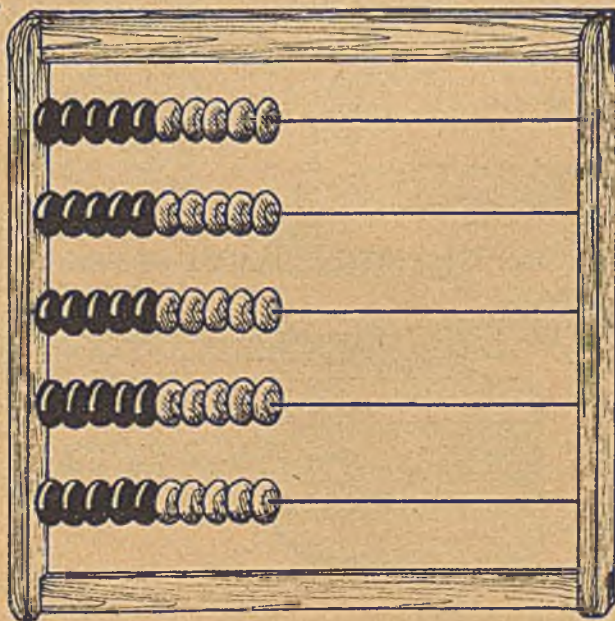

Przybory kreślarskie

134



135

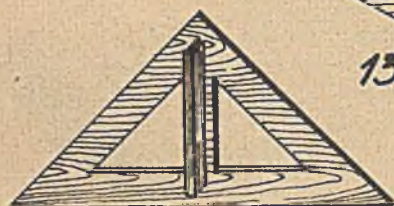

136

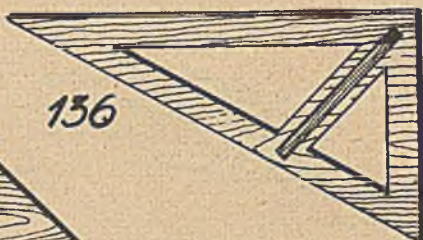

137

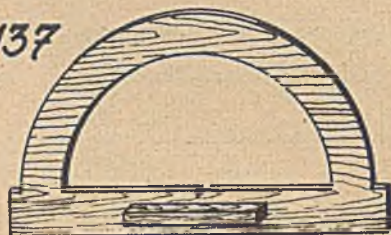

138



139



140



141

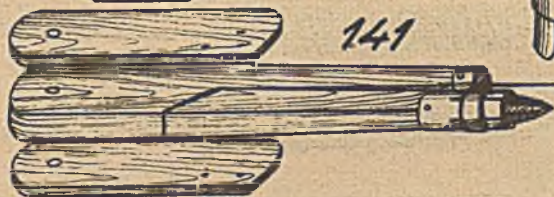

Siatki brył z kartonu i tektury

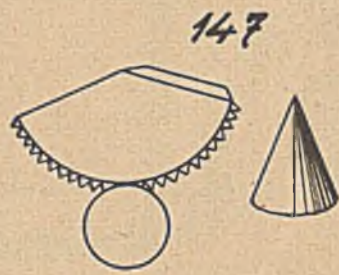
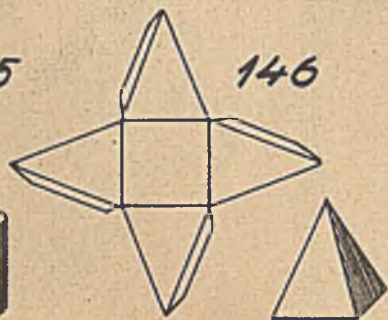
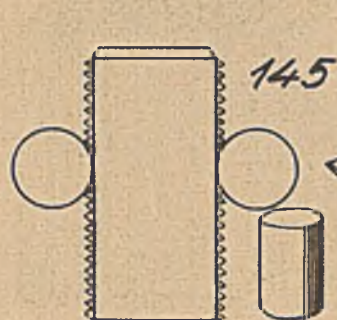
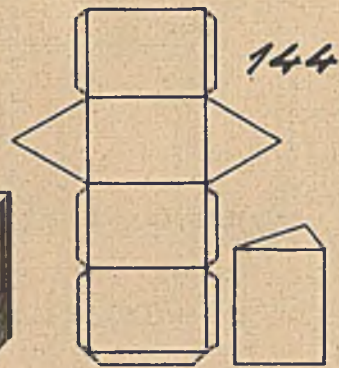
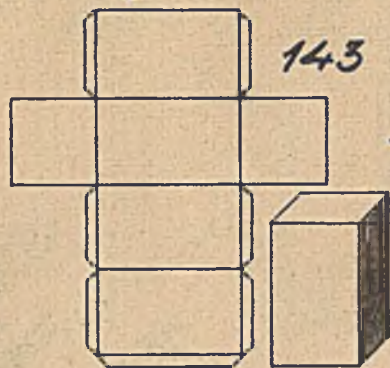
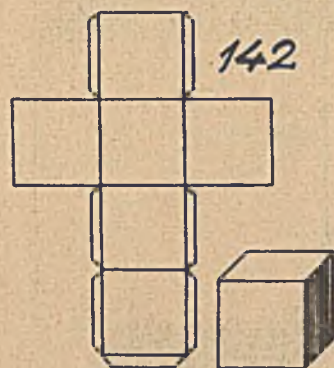

Metr kwadr., m^3 , $dc m^3$

148



149

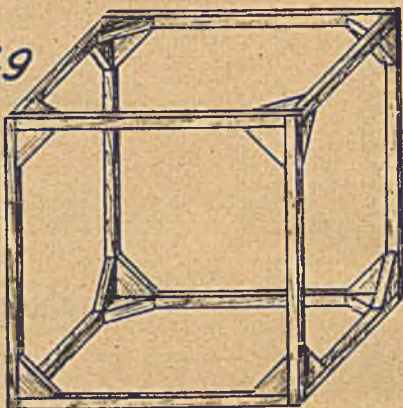

150

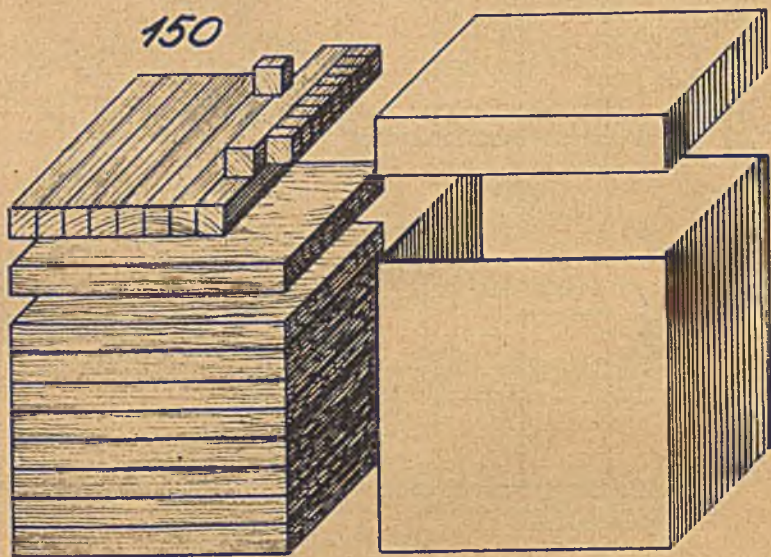

Szkielety brył

151

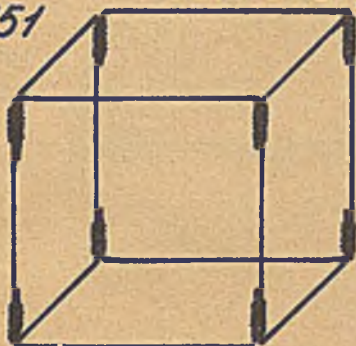

152

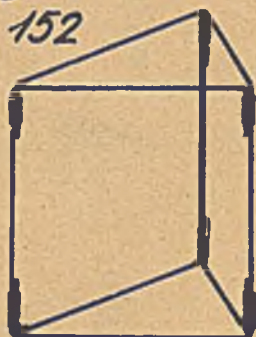

153

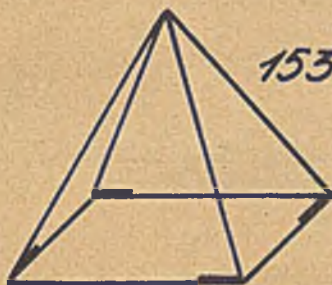

154



155



156



Bryły z drzewa

157



158



159

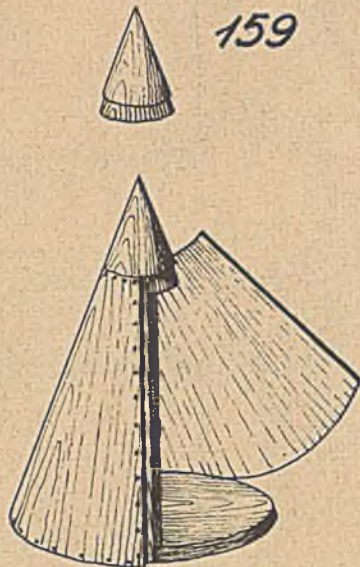

Gwiazdy na Boże Narodzenie

160

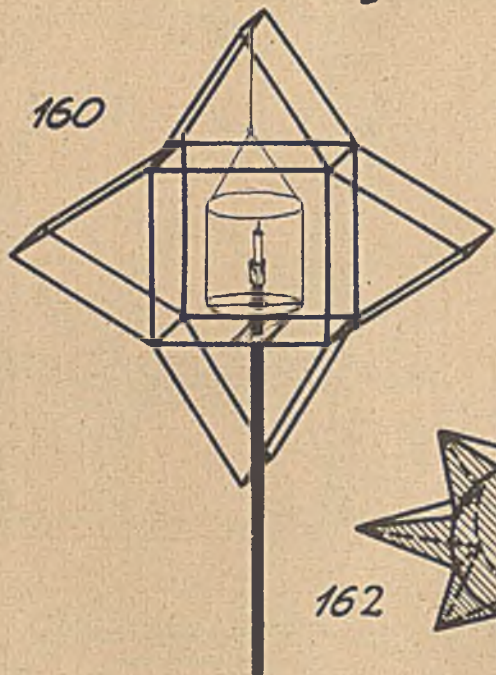

161

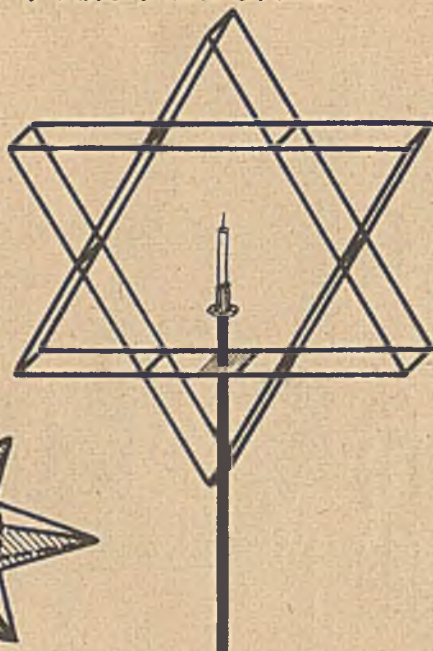

162

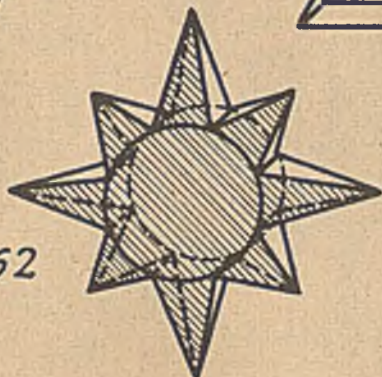

Szopki krakowskie

163

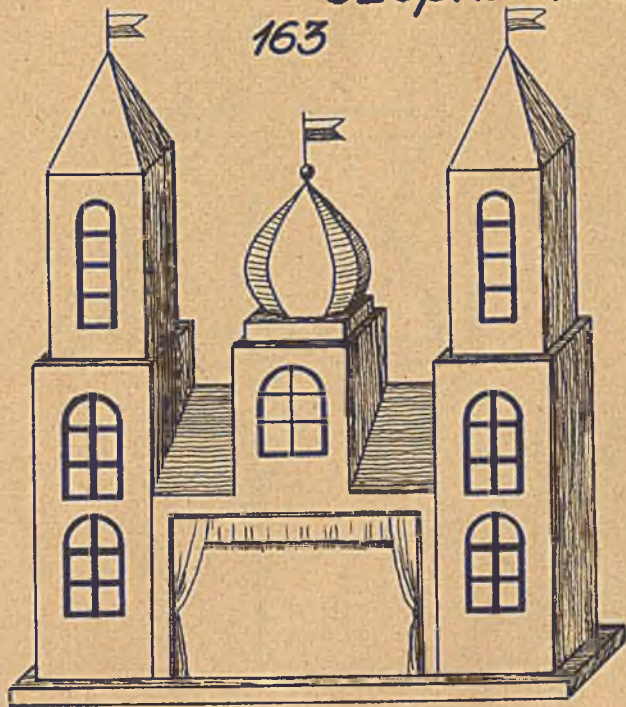

164

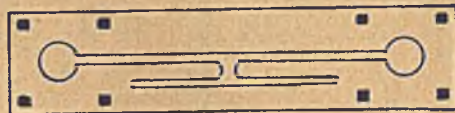
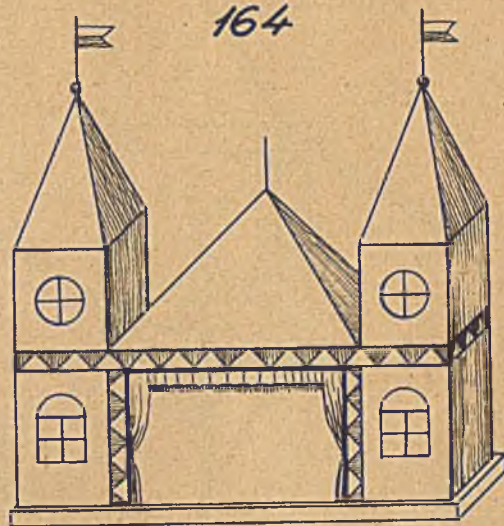

Pomoce do przedstawień

Pomoce do przedstawień

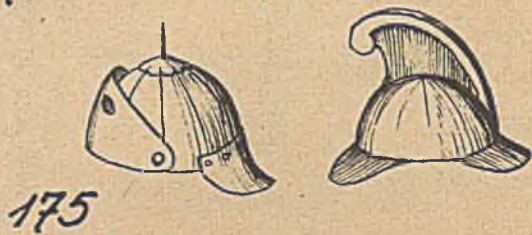
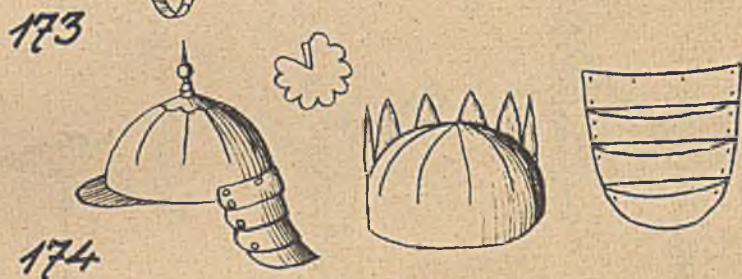
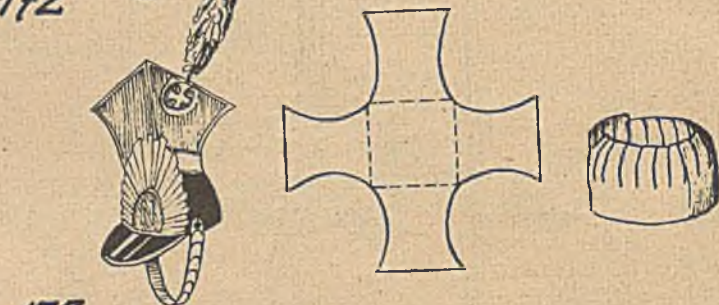

Czapki do przedstawień

176



177

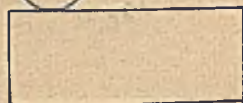

178

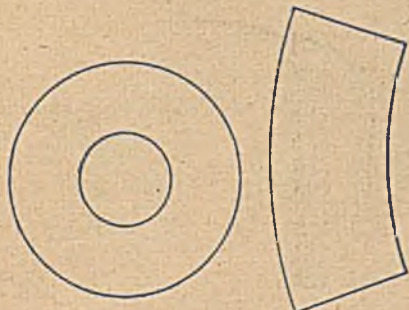

179

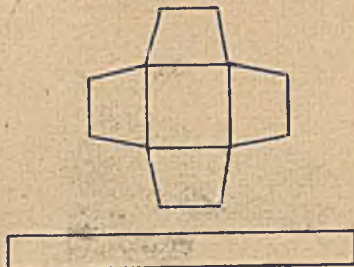

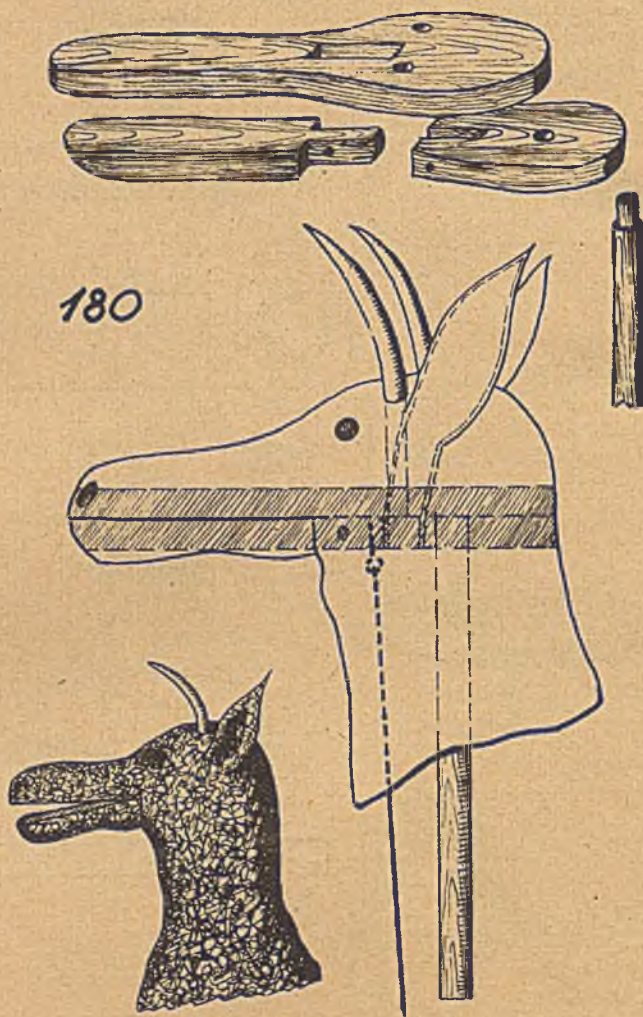
Turoñ

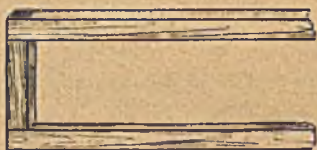
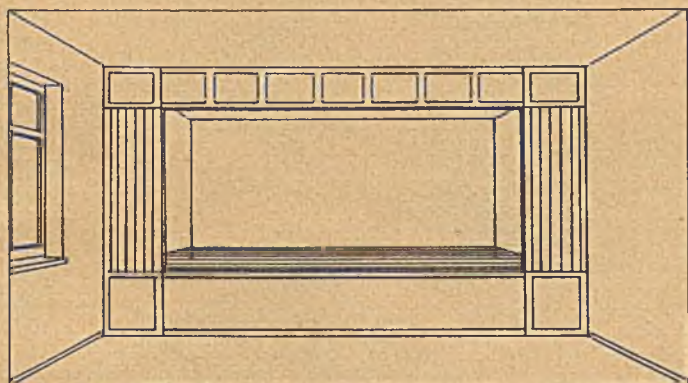
Składana scena szkolna

181

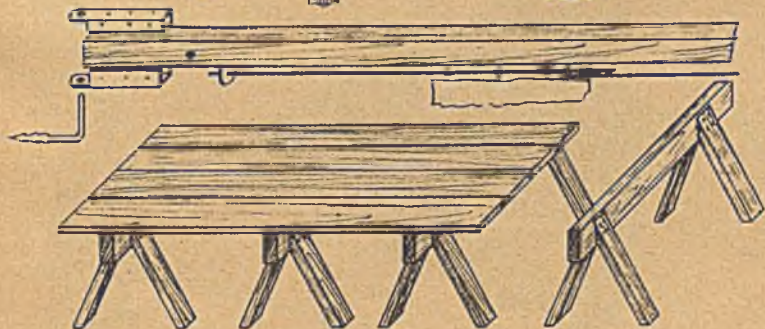

Latawce

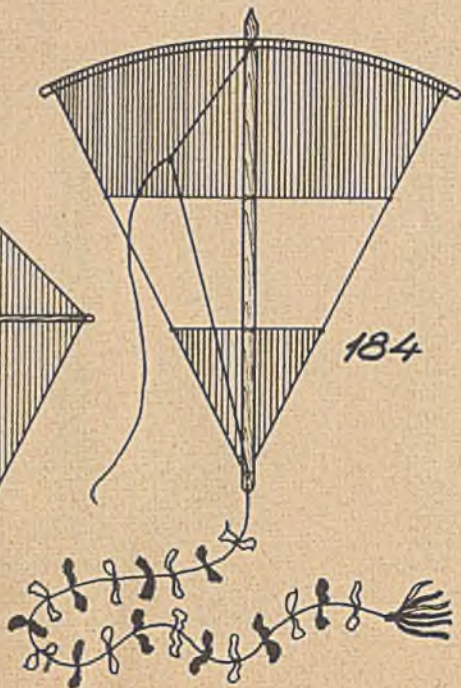
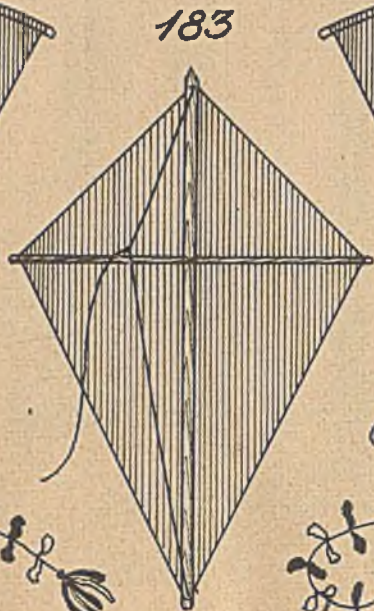
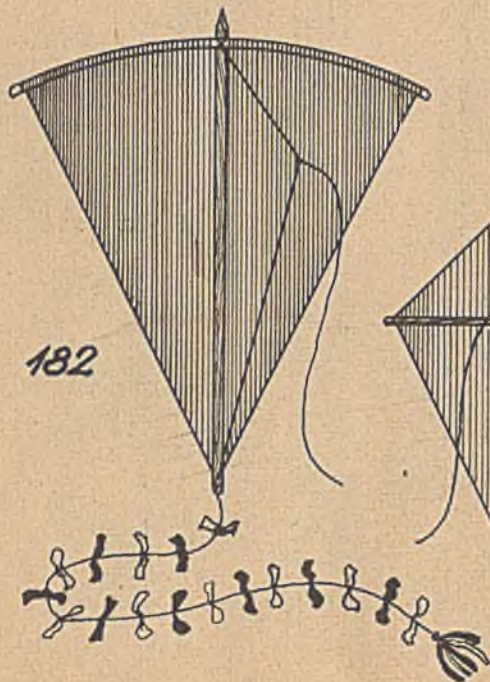

Przybory do ping-ponga

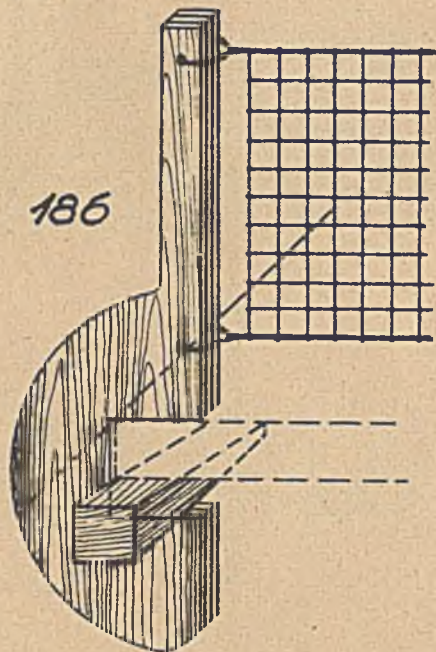
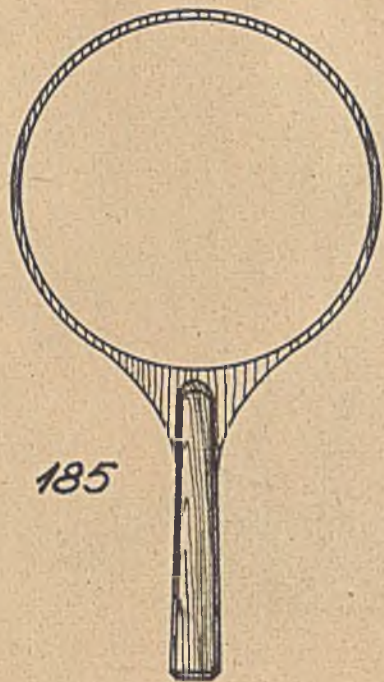

Kotatka

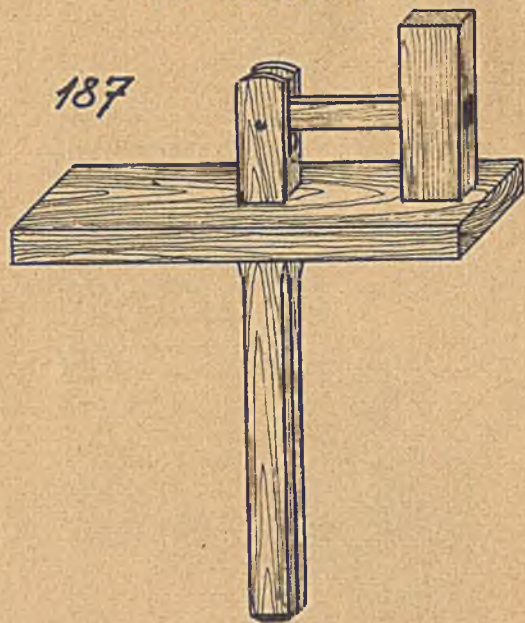

Trajkotka

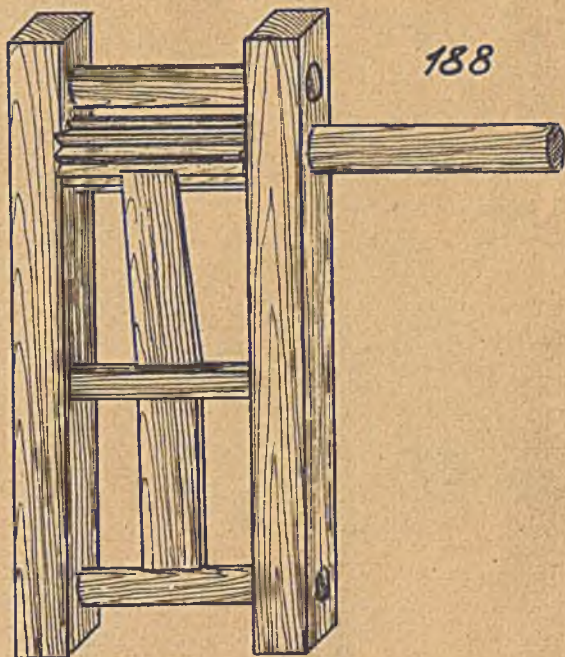

Modele kapliczek

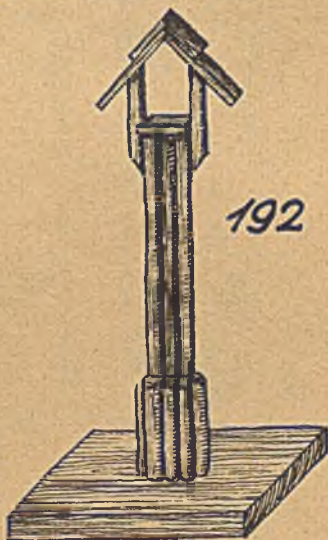
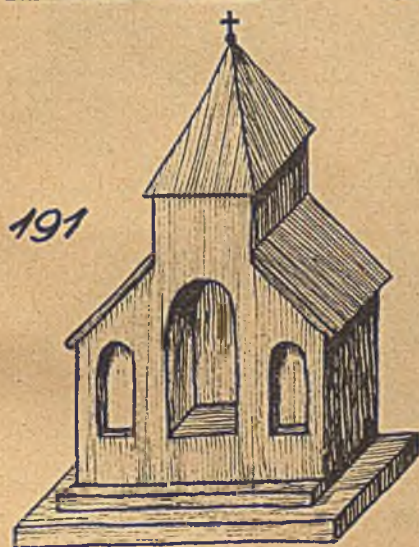
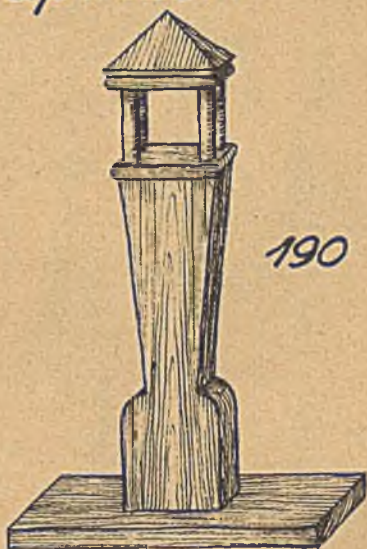
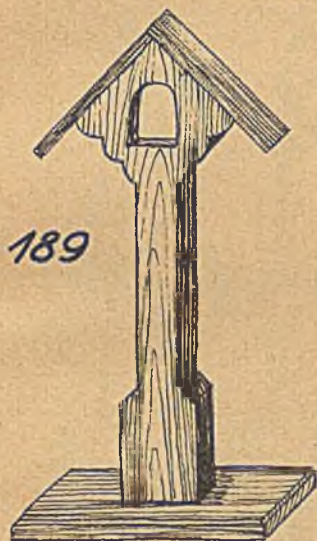

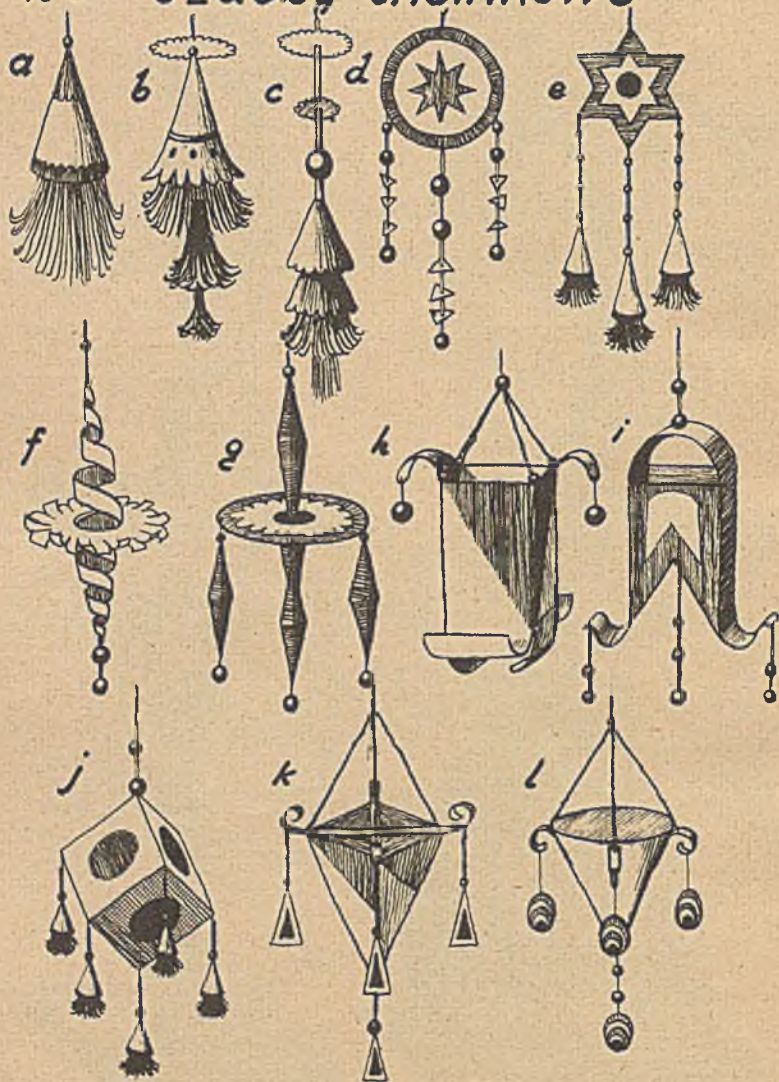
193 *Ozdoby choinkowe*

Prace z drzewa i drutu

194

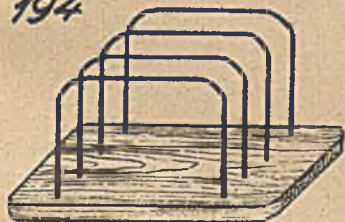

195

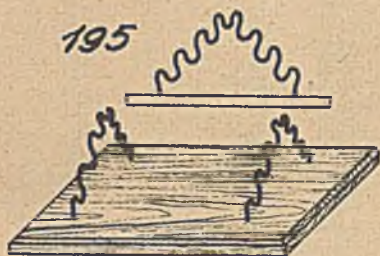

196



197

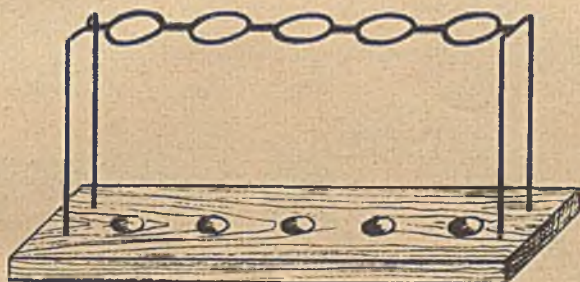

198

Prace ze szkła

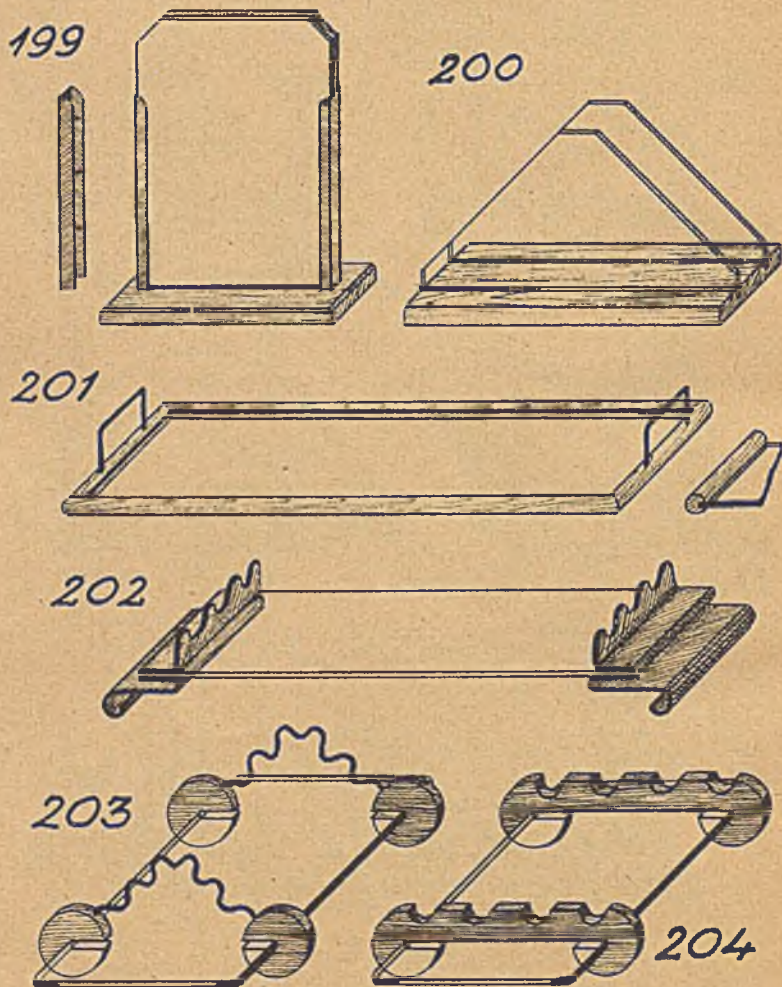

Latarnie

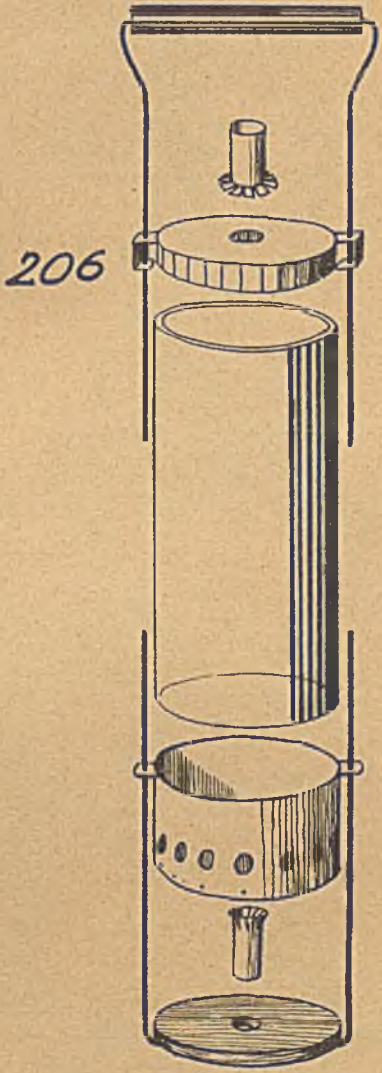

Lampy elektryczne



207



208



209

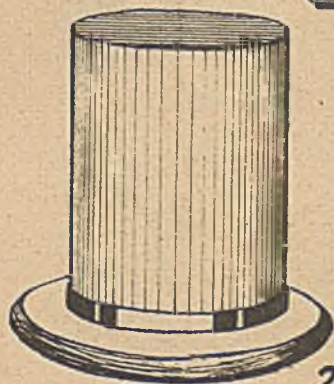

210

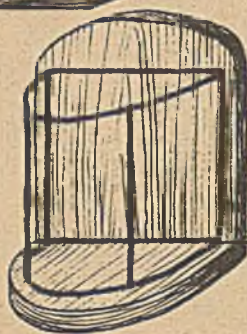

211

Sprzet harcerski

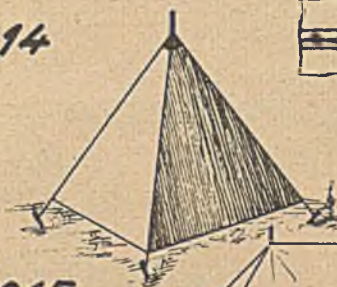
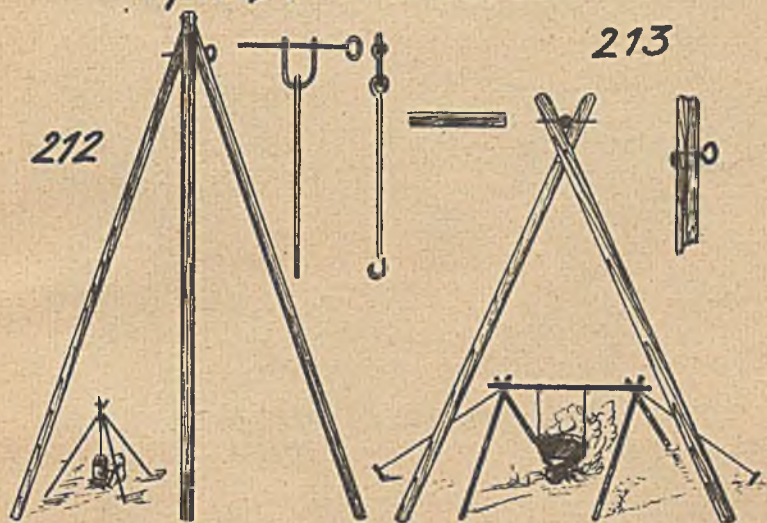

215

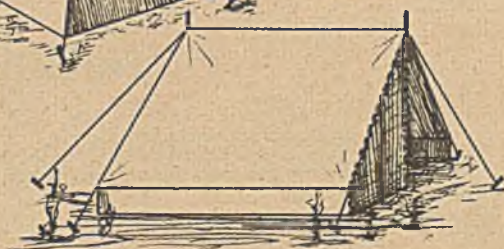

Krzesetka, stolik i tozko skladane

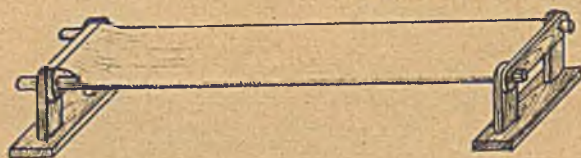
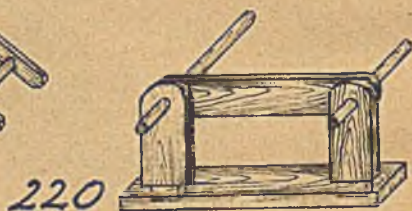
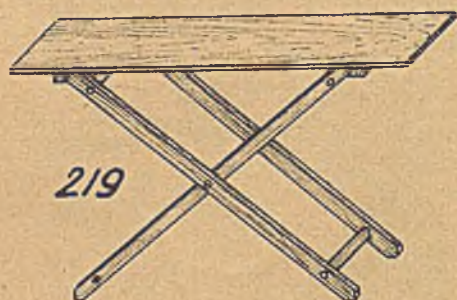
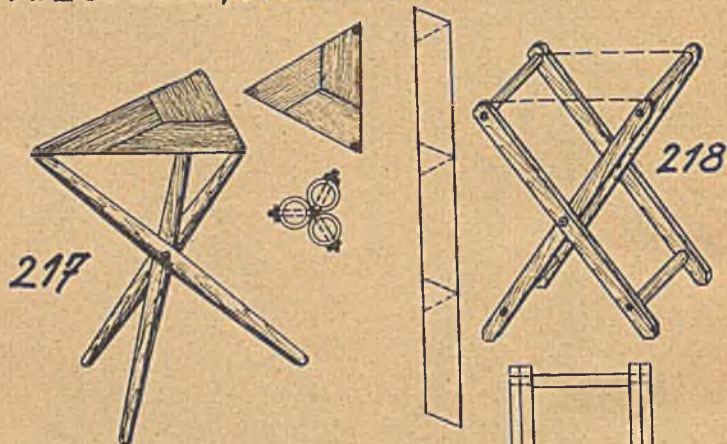

Łyżwy

221

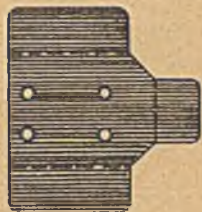

222



223



224

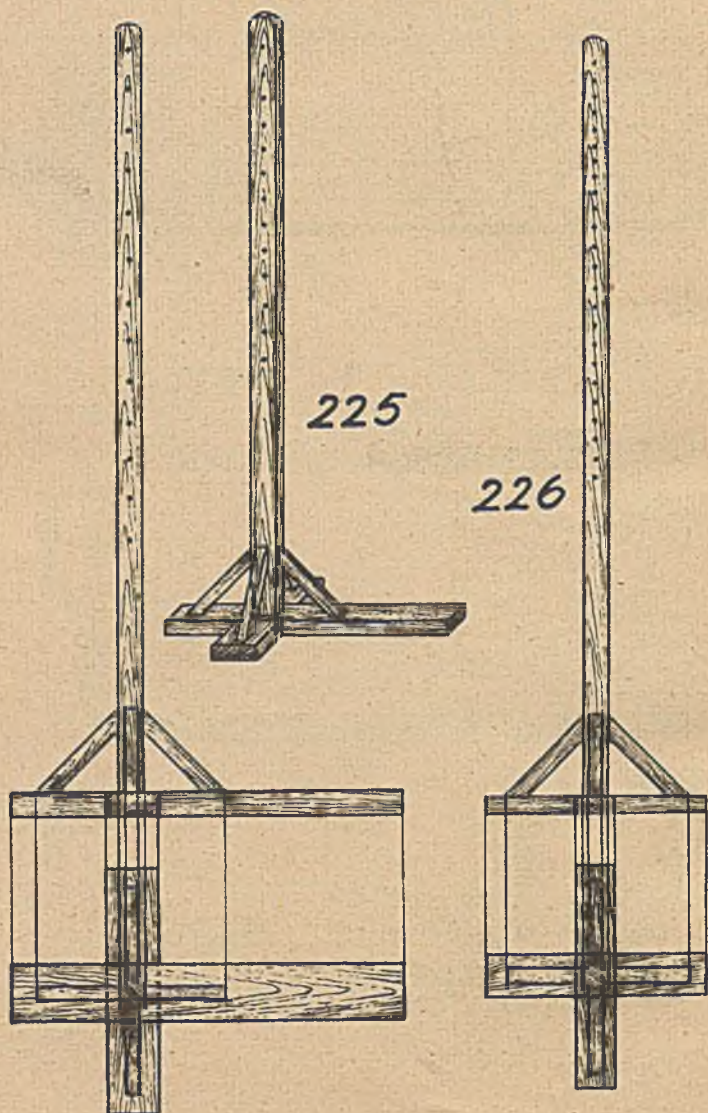

Stojaki do gier

Przybory sportowe

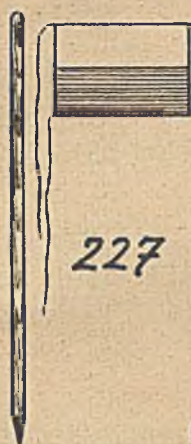

227

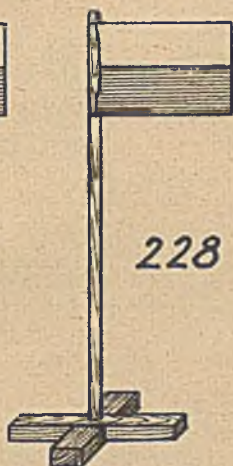

228

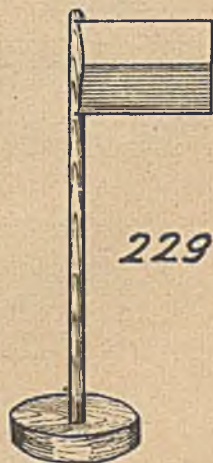

229

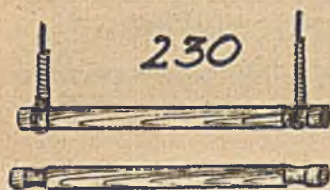

230



231

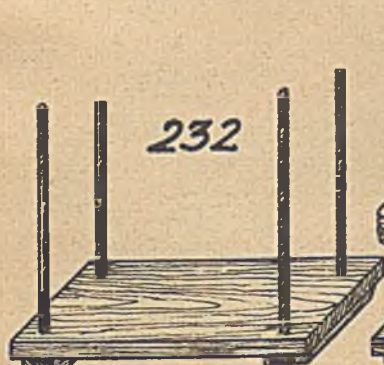

232

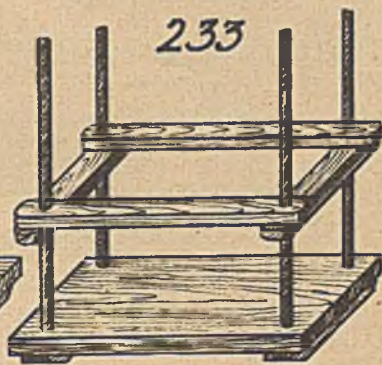

233

Sanki

234



235



236



237

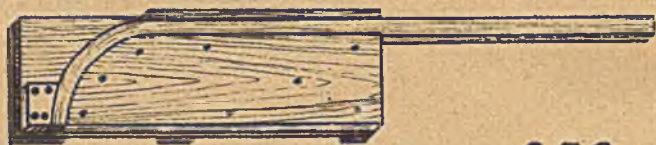
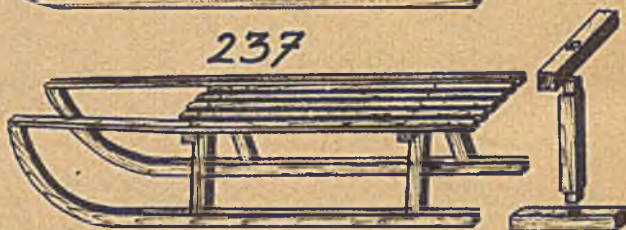

238

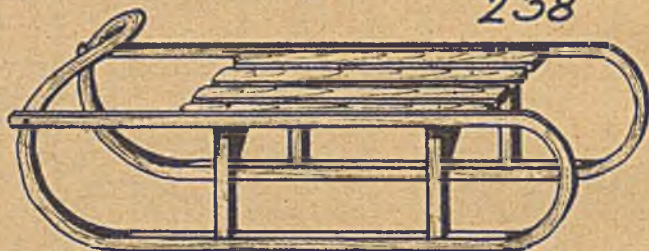

WYKAZ RYCIN

Palik, tabliczki i ogrodzenie (1—6)	3
Skrzynki do hodowli roślin (7—10)	4
Golębniki (11—14)	5
Półeczki i domki dla ptaków (15—18)	6
Karmidełka i poidelka (19—23)	7
Ławki i stoliki ogrodowe (24—28)	8
Wiwarium (29)	9
Terrarium (30)	10
Akwarium metalowe (31)	11
Klatki dla drobiu (32—35)	12
Klatki (36—39)	13
Inspekty (40)	14
Sprzęt ogrodniczy (41—45)	15
Prasa, łapka, listwy do obrazu (46—48)	16
Rozszerzalność metali (49)	17
Rozszerzalność metali (50)	18
Formy użytkowe ze szkła (51—54)	19
Lewary (55—57)	20
Rozpylacze, Oziębacz (58—63)	21
Butelka lejdejska, elektroskop (64—66)	22
Turbina (67)	23
Młynek Segnera (68)	24
Studnia (69)	25
Studnia (70)	26
Piec pokojowy (71)	27
Sikawka strażacka (72)	28
Przekrój cylindra parowego (73)	29
Statywy (74—75)	30
Statyw (76)	31
Waga (77)	32
Wahadło (78)	33
Dźwignia (79)	34
Równia pochyła (80)	35
Kołowrót i bloki (81—83)	36
Śmigło (84)	37
Koło wodne nasiębiejne (85)	38
Wiatrak (86)	39
Zegar wahadłowy (87)	40
Ekran (88)	41
Peryskop (89)	42
Ciemnie optyczne (90—91)	43
Pudełka i skrzynki na zbiory (92—95)	44

Igły magnetyczne (96—98)	45
Elektromagnes (99)	46
Elektromagnes-brzęczek (100)	47
Dzwonek elektryczny (101)	48
Obwód prądu (102)	49
Przyciski, rozdzielnik, klucz (103—106)	50
Motorek elektryczny (107)	51
Galwanoskop (108)	52
Detektor (109)	53
Detektor (110)	54
Detektor suwakowy (111)	55
Wiatrowskaz (112)	56
Poziomica (113)	57
Zegary słoneczne (114—115)	58
Deszczomierze (116—118)	59
Warstwice (119)	60
Warstwice (120—121)	61
Wykazanie kulistości ziemi (122)	62
Wykazanie kulistości ziemi (123)	63
Globus indukcyjny (124)	64
Gnomon, kątomierz, klinometr (125—128)	65
Zegary (129—130)	66
Liczydła (131—133)	67
Przybory kreślarskie (134—141)	68
Siatki brył z kartonu i tektury (142—147)	69
Metr kwadr., m ³ , dcm ³ (148—150)	70
Szkielety brył (151—156)	71
Bryły z drzewa (157—159)	72
Gwiazdy na Boże Narodzenie (160—162)	73
Szopki krakowskie (163—164)	74
Pomoce do przedstawień (165—171)	75
Pomoce do przedstawień (172—175)	76
Czapki do przedstawień (176—179)	77
Turoń (180)	78
Składana scena szkolna (181)	79
Latawce (182—184)	80
Przybory do ping-ponga (185—186)	81
Kołatka. Trajkotka (187—188)	82
Modele kapliczek (189—192)	83
Ozdoby choinkowe (193)	84
Prace z drzewa i z drutu (194—198)	85
Prace ze szkła (199—204)	86
Latarnie (205—206)	87
Lampy elektryczne (207—211)	88
Sprzęt harcerski (212—216)	89
Krzeselka, stolik i łóżko składane (217—220)	90
Łyżwy (221—224)	91
Stojaki do gier (225—226)	92
Przybory sportowe (227—233)	93
Sanki (234—238)	94

NAJBOGATSZY INFORMATOR W ZAKRESIE
WSPÓŁCZESNEJ WIEDZY i KULTURY

ŚWIAT i ŻYCIE

REDAKTOR NACZELNY
PROF. DR Z. ŁEMPICKI

NOWOCZESNY TYP
ENCYKLOPEDII

opracowany przy współudziale
najwybitniejszych uczonych
i specjalistów polskich.

Obejmuje pięć tomów bogato
ilustrowanych, z których cztery
pierwsze przedstawiają zagad-
nienia podstawowe we formie
zwięzłych, naukowo opracowa-
nych a jednocześnie przystępnie
i jasno ujętych monografii, tom
piąty zaś stanowi encyklopedię
podręczną a' zarazem klucz do
całości dzieła.

Cena kompletu w ozdobnej pię-
ciennej oprawie . . . zł 300,—
w półskórku 340,—

K S I A Ǻ Ż N I C A - A T L A S

Lwów, Czarnieckiego 12 — Warszawa 1, Nowy Świat 59