

vibration; measurement; wireless; acceleration; crane

**Tomasz HANISZEWSKI\* Damian GĄSKA**  
Silesian University of Technology, Faculty of Transport  
Kraśińskiego 8 Street, 40-019 Katowice, Poland  
\*Corresponding author. E-mail: [tomasz.haniszewski@polsl.pl](mailto:tomasz.haniszewski@polsl.pl)

## OVERHEAD TRAVELING CRANE VIBRATION RESEARCH USING EXPERIMENTAL WIRELESS MEASURING SYSTEM

**Summary.** The paper contains an operations and constructions description of the experimental wireless measuring system for measuring accelerations in bridge cranes, based on PHIDGET 1056 sensors. Developed experimental research and measuring methodology allows the use of the proposed wireless system on other cranes constructions. The paper also shows examples of the results of vibration measurements and FFT spectra, obtained on the basis of accelerations measurements.

## BADANIA PRZYSPIESZEŃ SUWNICY POMOSTOWEJ Z WYKORZYSTANIEM EKSPERYMENTALNEGO BEZPRZEWODOWEGO TORU POMIAROWEGO

**Streszczenie.** Artykuł zawiera opis zasady działania i konstrukcji eksperymentalnego bezprzewodowego toru pomiarowego do badań przyspieszeń w suwnicach pomostowych, opartego na układzie PHIDGET 1056. Opracowana metodyka doświadczalnych badań przyspieszeń umożliwia zastosowanie proponowanego rozwiązania także na innych konstrukcjach dźwigowych. W artykule przedstawiono również przykładowe wyniki pomiarów drgań oraz przykładowe widma FFT uzyskane na podstawie wykonanych pomiarów na badawczej suwnicy pomostowej.

### 1. INTRODUCTION

One of the main problems in the process of modeling the dynamic mechanisms of machines, is the verification of analytical data with those obtained from experiments. For cranes, which are characterized by intermittent motion, loads induced in a crane by accelerations or decelerations caused by drives forces, are classified as regular loads. Hoisting a load or sudden release of a part of the hoist load induces vibrations of cranes load-carrying structure [6]. Calculation of dynamic forces can be done by test or by experimentally proven analytical methods. So far, however, studies of this kind were rarely carried out for the cranes [1 - 4].

### 2. RESEARCH OBJECT

In this paper, a study subject is an experimental research overhead travelling crane with a capacity of 5000 [kg] and span of the bridge 20 [m]. Cranes belong to the most common load-lifting machines. Their structures consist of a mobile platform (crane load carrying structure) along the hall with hoisting winch or a trolley moving along girders [5].



Fig. 1. Experimental research crane – OBRDiUT "Detrans" in Bytom (place of installation)

Rys. 1. Eksperymentalna suwnica badawcza – OBRDiUT "Detrans" w Bytomiu (miejsce instalacji)

Table 1

Experimental research cranes characteristics

	Designation	Units	Quantity
Load capacity	Q	[kg]	5000
Span	$L_{\text{mostu}}$	[m]	20
Load-lifting height	$H_{p \text{ max}}$	[m]	16
Hoisting speed	$v_p$	[m/s]	0,208
Travelling speed of hoisting winch	$v_{jw}$	[m/s]	0,625
Travelling speed of cranes structure	$v_{jm}$	[m/s]	0,472
Supply voltage	U	[V]	380

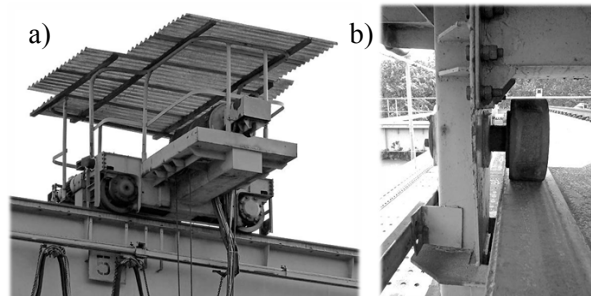

Fig. 2. a) hoisting winch, b) arm of the guide rollers – OBRDiUT "Detrans" in Bytom

Rys. 2. a) wózek wciągarki, b) ramię z rolkami prowadzącymi – OBRDiUT "Detrans" w Bytomiu

Considered experimental structure (Fig. 1, 2) as one-girder, includes a two wheels hoisting winch, supported on the construction of the girder through arm with rollers, moving along the side edge of the girder (Fig. 2b). Table 1 shows the general characteristics of the experimental research crane, on the basis of the technical documentation.

### 3. CONSTRUCTION AND INSTALLATION OF EXPERIMENTAL WIRELESS MEASURING SYSTEM

For verification of numerical models, it is necessary to compare the analytical data with those obtained on the basis of the measurements. Therefore, the experimental wireless measuring system was made. It permits measurements of crane load-carrying structure accelerations in the real conditions. During the study two independent measurement channels were used. This approach allowed to verify the experimental wireless measuring system. The construction of the measurement channels is shown schematically in Fig. 3

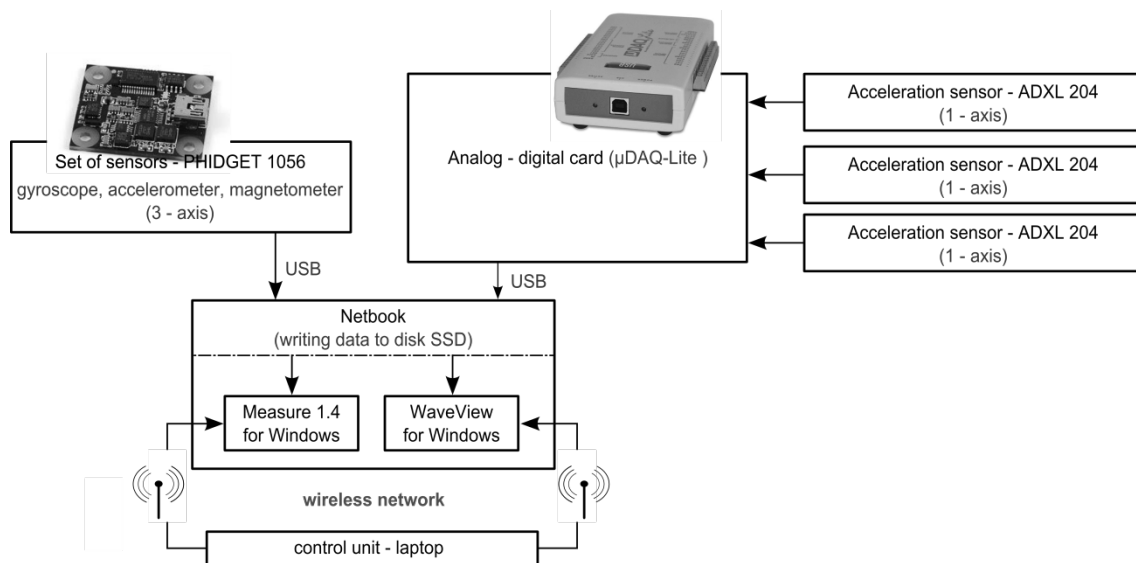

Fig. 3. Block diagram of the two independent measurement channels  
 Rys. 3. Schemat blokowy dwóch niezależnych torów pomiarowych

The first measuring channel is based on the set of three ADXL 204 acceleration sensors and the analog digital card  $\mu$ DAQ-Lite with WAVE VIEW software for Windows, the company Eagle Technology [13, 14]. Second channel – experimental wireless measuring system consists of the PHIDGET 1056 meter circuit (Fig. 4) namely: magnetometer, gyroscope and accelerometer, where each of them can perform measurements in three independent orthogonal axes. Experimental wireless measuring system parameters are given in Table 2. For both measurement channels the control unit software (laptop) was accompanied by an SSD (Solid State Drive), which recorded data. The use of solid state technology excluded influence of structure vibration contained in the conventional magnetic medium where drives are rotating.

Table 2

PHIDGET 1056 meter circuit parameters [17]

	Quantity	Units
Measurement axes	3	[-]
Maximum sampling rate	250	[Hz]
Powered from USB port	4.75 ÷ 5.25	[VDC]
Power consumption	max. 45	[mA]
Operating temperature range	0 to 70	[°C]
USB version	12	[MBit]
<b>Gyroscope</b>		
The measuring range for each axis	±400	[°/s]
Drift	4	[°/m]
Resolution	0.02	[°/s]
<b>Accelerometer</b>		
The measuring range for each axis	±5.1	[g]
Resolution	230	[μg]
<b>Magnetometer / compass</b>		
Shift from the north (typical)	2	[°]
Resolution	400	[μG]
The measuring range for each axis	±4.1	[G]



Fig. 4. a) PHIDGET 1056 measuring circuit, b, c) measuring head with magnetic holder  
Rys. 4. a) Układ PHIDGET 1056, b, c) głowica pomiarowa z uchwytem magnetycznym

Experimental wireless measuring system has following:

**advantages:**

- magnetics holder for easy attachment on any crane without having to make changes to the test object (Fig. 4b),
- small size allows installation in any place of steel construction,
- simultaneously measured accelerations, and the angles of rotation in three independent orthogonal axes,
- possible statement of a remote connection to the sensor,
- high accuracy of measurement (tab. 2),
- system allows testing of the dynamics of lifting loads in order to identify accelerations and thus the surplus of dynamic factors, for regular and exceptional loads according to the European normative acts calculations [6].

**disadvantages:**

- due to the applied magnetics holder is not possible to measure the magnetic field due to the strong interference,
- system requires authors software that allows data acquisition and its control (Fig. 5).

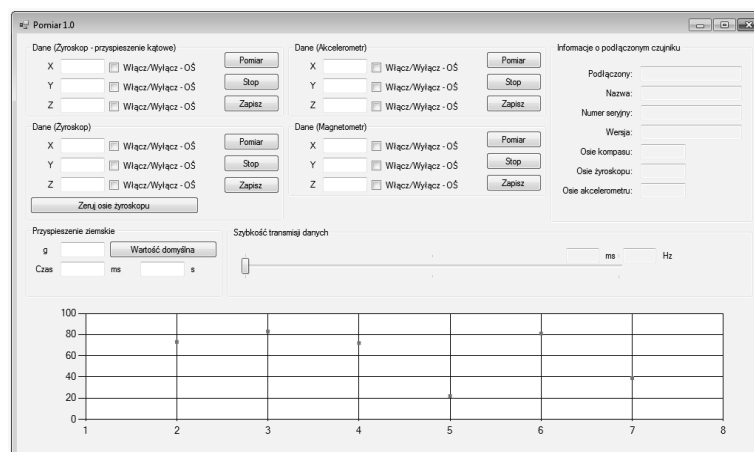

Fig. 5. The software for controlling the magnetic measuring head  
Rys. 5. Program sterujący głowicą pomiarową

Both measurement channels are equipped with special external antenna and a wireless card broadening the scope of wireless signal and with potential use as an access point (Fig. 6). According to the documentation the range of such equipped system is about 500 [m] in the open space. Because the PHIDGET 1056 sensors do not have software for data acquisition and only API (Application Programming Interface) [15], a special software for Windows was written to control the sensors (Fig. 5). This program allows data acquisition directly from the 1056 via a USB port and remote

connection<sup>a)</sup> to the sensor using a LAN or <sup>b)</sup> Web. The experimental wireless measuring system also includes a USB camera, which allows to observe a selected area of research with wireless connectivity.



Fig. 6. Measuring circuit for field tests: a) laptop with wi-fi antenna and analogue-to-digital card, b) observation camera

Rys. 6. Zestaw do badań terenowych: a) laptop z anteną wi-fi oraz karta analogowo-cyfrowa, b) kamera obserwacyjna

This configuration allows network communication with the experimental wireless measuring system, through the so-called remote connection using wireless or wired network, allowing direct access to the control sensor, or a direct network connection to the PHIDGET 1056 sensors. Additional functionality is the ability to perform measurements for any configuration of the measurement axis: x, y, z for any measurement system, i.e. such as an accelerometer or gyroscope.

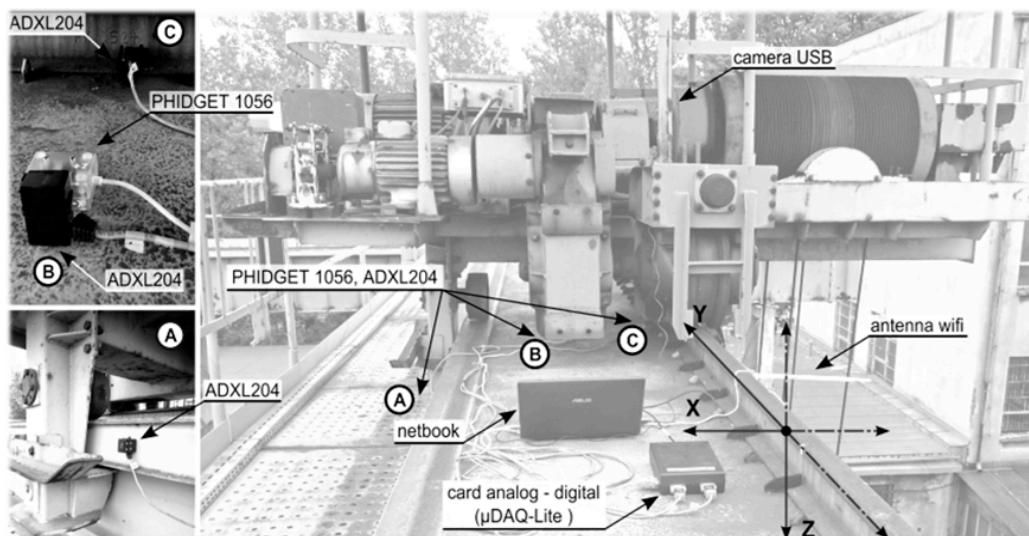

Fig. 7. Diagram showing the location of the measuring circuits on test object (Experimental research crane – OBRDiUT "Detrans" in Bytom)

Rys. 7. Schemat przedstawiający rozmieszczenie torów pomiarowych na badanym obiekcie

The measurement data are stored in a text file with data separated by a semicolon, which allows direct import of such data to the worksheet. In Figs 6, 7 and 8 the positions of the measurement channels on test object are shown (Experimental research crane – OBRDiUT "Detrans" in Bytom).

#### 4. MEASUREMENTS AND VERIFICATION OF MEASUREMENT CHANNELS

Experimental vibration tests using designed measurement circuits were made in OBRDiUT Detrans in Bytom for one-girder overhead traveling crane. The measurements were performed for the winch located in the middle of the cranes span, which is the most unfavorable load case. The study was performed according to the plan shown in Table 3, where the value of the load  $Q$  is 1800 [kg] and height  $H1$  and  $H2$  respectively equal to the cranes lifting height and half of it.

Table 3

Vibration tests plan

Test No	Test characteristic	Number of repeats
1	Lifting the empty hook	2
2	Lowering an empty hook	2
3	Lifting the load $Q$ on $H1$ height from the ground - loose ropes	3
4	Lowering load $Q$ of $H1$ height to the ground	3
5	Lifting the load $Q$ on $H1$ height from the ground - pre-tensioned ropes	3
6	Lowering load $Q$ of $H1$ height to the ground	3
7	Lowering load $Q$ of $H2$ height to the ground	3
8	Lifting the load $Q$ on $H2$ height from the $H1$ height	3

Diagram of the coordinate system is shown in Fig. 8. For measuring circuit which uses a set of sensors ADXL204 signal was sampled with a frequency of 1000 [Hz] on each channel. In the case of the measurement channel based on a set of PHIDGET 1056 sensors (experimental wireless measuring system) sampled signal was sampled with a frequency of 250 [Hz] and the channel measurement resolution was 230 [ $\mu g$ ] ( $g$  - gravitational acceleration,  $g = 9.81 \text{ ms}^{-2}$ ).

The research has achieved a number of experimental measurement data, mainly determined acceleration values for the three perpendicular axes of coordinate system, where for the  $Z$  axis (Fig. 8) values were verified by comparing the data from both measurement channels (sensors are in the same position Fig. 7).



Fig. 8. Axis of measurement system for test object (Experimental research crane – OBRDiUT "Detrans" in Bytom)

Rys. 8. Schemat założonych osi pomiarowych na obiekcie badawczym (Experimental research crane – OBRDiUT "Detrans" in Bytom)

In order to compare the signals of both measurement channels two numerical estimates were determined [7 - 10]:

- average level of vibration:

$$X_{AVE} = \frac{1}{T} \int_0^T |x(t)| dt \quad (1)$$

where: T – period of vibration [s]; x – vibration signal (acceleration) [ $\text{ms}^{-2}$ ]; t – time [s].

- RMS value of vibration:

$$X_{RMS} = \sqrt{\left( \frac{1}{T} \int_0^T x^2(t) dt \right)} \quad (2)$$

Coefficients for vibration signal described by formulas (1-2), obtained by measuring from both measuring circuits for the Z axis, are shown in Figure 9.

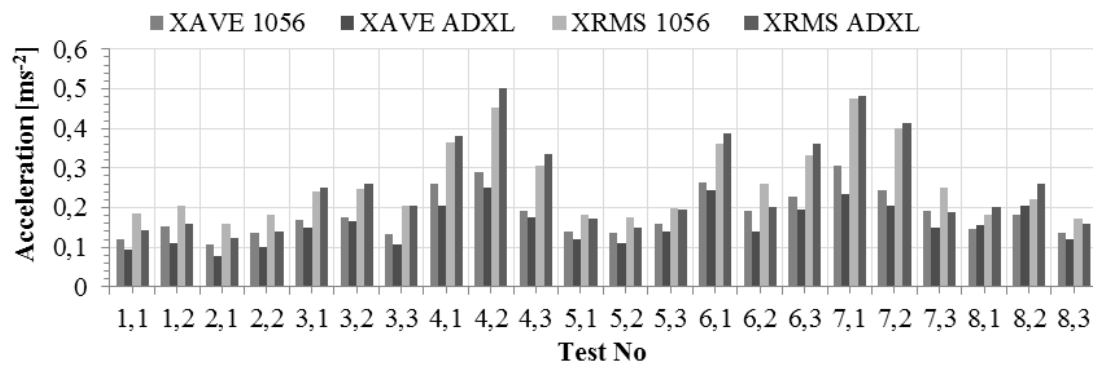

Fig. 9. Summary of the average level of vibration and RMS value of vibration for both measurement channels (respectively a comma determine the test No (Table 3))

Rys. 9. Zestawienie wartości średniej bezwzględnej oraz skutecznej dla sygnału drganiowego względem osi Z badanego układu dla obu torów pomiarowych (odpowiednio za przecinkiem oznaczono nr wykonanej próby (tab. 3))

As can be seen in the Fig. 9 the values obtained from the two measurement channels are close to each other, and therefore subjected to further analysis are data obtained from measuring circuit based on a set of PHIDGET 1056 sensors.

## 5. RESULTS OF EXPERIMENTAL TESTS

After verifying the data obtained from two independent measurement channels a preliminary analysis of the received waveforms was conducted. For this purpose, the acceleration values were verified and in particular the maximum value was examined by subjecting the signal spectral analysis. By using FFT was verified or the maximum acceleration values are associated with the process of lifting or with other components, such as the drive (mechanisms) introducing distortions in the signal.

To determine the frequency of vibration within the measuring point (Fig. 7 z-axis), a fast Fourier transform method was used. Plotting the output of the transform as a function of frequency the vibration signal amplitude spectra was obtained, and on this basis the fundamental frequency of vibration was determined. Based on the work [11, 12, 14, 16] a script to perform FFT for the selected range of data was created. This script performs N-point transform with a sampling frequency 250 [Hz]. As in accordance of the work [12], there is symmetry in the results of the FFT the script draws only half the data, which in this case is in the range from 0 [Hz] to 125 [Hz]. In order to protect against the phenomenon of spectral leakage, a windowing operation using Hamming window was applied in accordance to the work [12] that minimize discontinuities in the sampling interval

endpoints. The results are shown in Table 4. Due to the low significance, studies on lifting and lowering the unloaded hook were omitted. Exemplary results of the measurements of acceleration and amplitude spectra are shown in Figures 10-12. The results were discussed for the Z-axis, representing the direction of the vibration relating the load Q.

Table 4

Summary of the main frequency values obtained by spectral analysis

Test No	Test characteristic	ADXL (Hz)	1056 (Hz)
3.1	Lifting the load Q on H1 height from the ground - loose ropes	3,65	3,65
3.2		3,65	3,60
3.3		3,65	3,66
4.1	Lowering load Q of H1 height to the ground	4,58	4,58
4.2		4,52	4,49
4.3		4,55	4,55
5.1	Lifting the load Q on H1 height from the ground - pre-tensioned ropes	3,70	3,69
5.2		3,85	3,72
5.3		3,69	3,75
6.1	Lowering load Q of H1 height to the ground (second time)	4,60	4,58
6.2		4,58	4,57
6.3		4,6	4,58
7.1	Lowering load Q of H2 height to the ground	4,54	4,46
7.2		4,52	4,43
7.3		4,48	4,45
8.1	Lifting the load Q on H2 height from the H1 height	3,75	3,75
8.2		3,78	3,78
8.3		3,75	3,81

Figure 10a shows the acceleration of the girder characteristics when lowering the load with hitting the ground. It has been observed that the impact of load on the ground induces surface vibration causing an increase in the level of girders acceleration amplitudes  $-2.3 \div 2.2$  [ $\text{ms}^{-2}$ ]. The waveform described in Figure 10b shows the amplitude spectrum of fast Fourier transform, the dominant frequency is the value 4.58 [Hz] which corresponds to the frequency of vibration associated with lifting the load, confirming that the acceleration values obtained on oscillogram refer to vibrations caused by lifting or lowering loads.

Sample test results for the case, when the load is lifted while initial condition are loose or tight ropes are shown in Figure 11.

It has been observed that lifting the load at a non-pre-tensioned ropes increases the accelerations amplitude to a value  $(-3,75 \div 2,27)$  [ $\text{ms}^{-2}$ ]. In the case of lifting the load with pre-tensioned ropes achieved accelerations are much smaller  $(-0,78 \div 0,91)$  [ $\text{ms}^{-2}$ ]. For the above-mentioned cases Figures 12a and 12b shows the amplitude spectrum of fast Fourier transform, where the vibration frequency reaches the value 3.65 [Hz] and 3.72 [Hz]. Both values correspond to the frequency of vibration by lifting the load in the Z-axis.

## 6. CONCLUSIONS

Presented experimental wireless measuring system is designed to tests the dynamic characteristics of the crane structures, and precisely - to determine the accelerations of these structures and indirectly regular loads required for dimensioning according to European standards. In addition, the system has high accuracy and is equipped with wireless data transmission.

The measuring head has an original, simple construction, and its installation on the crane does not require any structural changes in the structure, moreover, it allows mounting on any metal part of the crane.



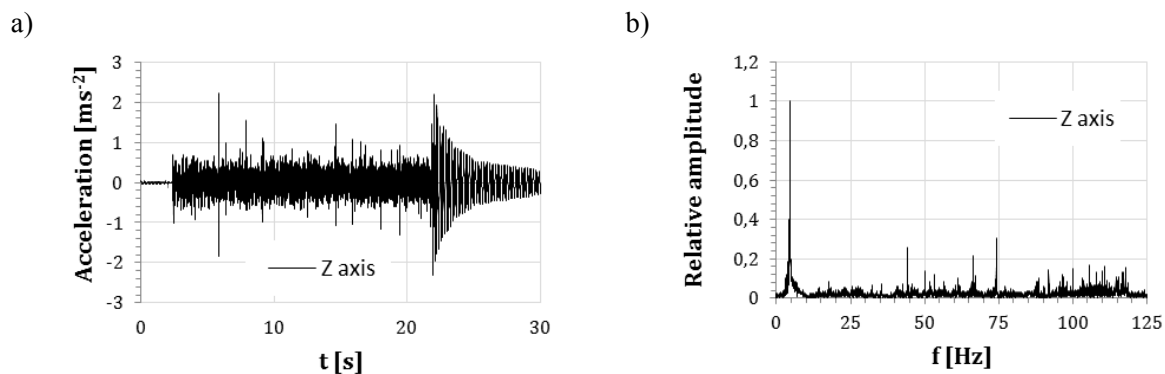

Fig. 10. a) Girders acceleration characteristics when lowering the load with hitting the ground (Table 4 - point. 4.1), b) FFT spectrum of the signal registered when lowering the load with hitting the ground (Table 4 - point. 4.1)

Rys. 10. a) Przebieg przyspieszeń środka dźwigara przy opuszczaniu ładunku z uderzeniem o podłoże (tab. 3 - pkt. 4.1), b) widmo amplitudowe FFT dla sygnału zarejestrowanego przy opuszczaniu ładunku z uderzeniem o podłoże (tab. 4 - Nr badania. 4.1)

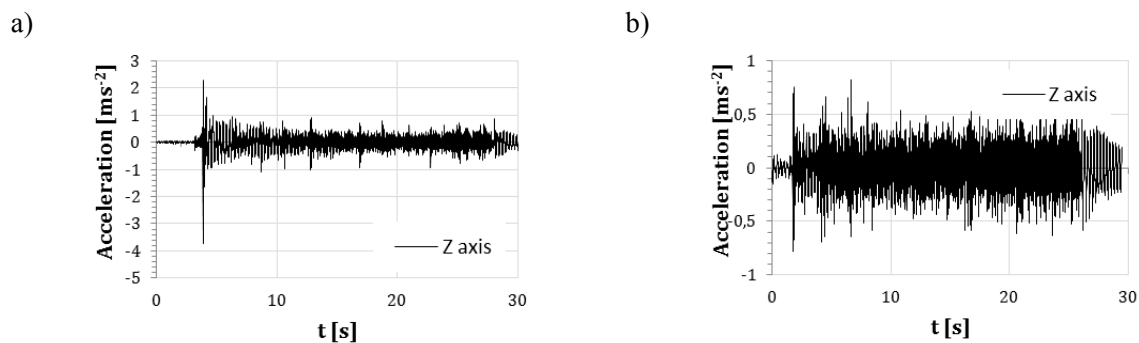

Fig. 11. a) Girders acceleration characteristics when lifting load (initial condition - loose ropes) (Table 4 - point. 3.1), b) girders acceleration characteristics when lifting load (initial condition - pre-tensioned ropes) (Table 3.3 - point. 5.2)

Rys. 11. a) Przebieg przyśpieszeń dźwigara przy unoszeniu ładunku (warunek początkowy - luźne ciężna) (tab. 4 - Nr badania 3.1), b) przebieg przyśpieszeń dźwigara przy unoszeniu ładunku (warunek początkowy - wstępnie napięte ciężna) (tab. 4 - Nr badania 5.2)

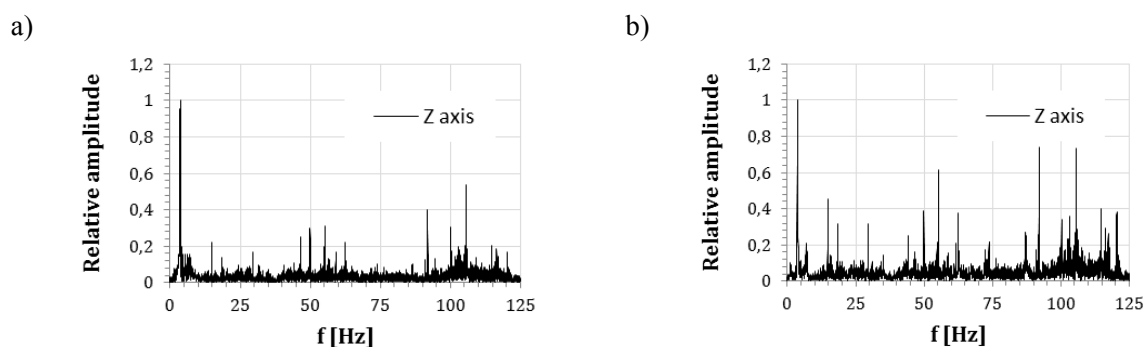

Fig. 12. a) FFT spectrum of the signal amplitude registered by lifting load (initial condition - loose ropes) (Table 4 - point. 3.1), b) FFT spectrum of the signal amplitude registered by lifting load (initial condition - pre-tensioned ropes) (Table 4 - point. 5.2)

Rys. 12. a) Widmo amplitudowe FFT dla sygnału zarejestrowanego przy unoszeniu ładunku (warunek początkowy - luźne ciężna) (tab. 4 - Nr badania 3.1), b) widmo amplitudowe FFT dla sygnału zarejestrowanego przy unoszeniu ładunku (warunek początkowy - wstępnie napięte ciężna) (tab. 4 - Nr badania 5.2)

The FFT amplitude spectrum, represent the range 3,6-4,6 [Hz]. These values are similar to those determined by analytical research - 4.14 [Hz]. That shows that the acceleration values corresponding to the specified frequency values are associated with the process of lifting the load.

Studies carried out in this paper were preliminary tests, where the resulting characteristics of the girders acceleration which can be used in simulation studies of the hoisting mechanism of crane for verification of a new developed numerical model, containing more specific mathematical ropes model, based on the Bouc-Wen model.

### Acknowledgements

The work was co-financed by the European Union under the European Social Fund within the project "Activation of the academic community, as part of the Regional Innovation Strategy" POKL.08.02.01-24-019/08 ". Numerical calculations were carried out in the Matlab, shared in the calculation of the grant number: MNiSW/IBM\_BC\_HS21/PŚląska/047/2011.

### Bibliography

1. Bińkowski, W. & et al. *Badania rozkładów obciążeń ruchowych dwu suwnic pomostowych II i IV grupy napięcia pracy*. Praca badawcza Instytutu Podstaw Konstrukcji Maszyn Politechniki Śląskiej o symb. NB-39/RMK/74/75. Gliwice: Politechnika Śląska. 1975. [In Polish]
2. Chmurawa, M. & Gąska, D. Badanie dynamiki podnoszenia ładunku w suwnicy. In: *Zeszyty Naukowe. Transport*. Gliwice: Politechnika Śląska. 2004. No. 53. P. 35-42. [In Polish]
3. Gallos, M. & Kulig, J. *Badania główne obciążeń eksploatacyjnych suwnic bramowych*. Praca bad. OBRDiUT „Detrans” o symb. BW-471044. Bytom: Detrans. 1978. [In Polish]
4. Markusik, S. & Gąska, D. & Witaszek, K. Badania przyspieszeń i poziomów drgań w suwnicach pomostowych. In: *Zeszyty Naukowe. Transport*. Gliwice: Politechnika Śląska. 2007. No. 63. P. 181-186. [In Polish]
5. Piątkiewicz, A. & Sobolski, R. *Dźwignice*. Warszawa: WNT. 1978. [In Polish]
6. PN-EN 13001-2:2013. *Bezpieczeństwo dźwignic. Ogólne zasady projektowania. Część 2: Obciążenia*. Warszawa: Polski Komitet Normalizacyjny. 57 p. [In Polish]
7. Cempel, C. *Diagnostyka wibroakustyczna maszyn*. Warszawa: PWN. 1989. [In Polish]
8. Cempel, C. *Podstawy wibroakustycznej diagnostyki maszyn*. Warszawa: WNT. 1982. [In Polish]
9. Gryboś, R. *Drgania maszyn*. Gliwice: Wydawnictwo Politechniki Śląskiej. 2008. [In Polish]
10. Kucharski, T. *System pomiaru drgań mechanicznych*. Warszawa: WNT. 2002. [In Polish]
11. Haniszewski, T. *Badanie zjawisk dynamicznych podczas podnoszenia ładunku na wybranym modelu suwnicy pomostowej*. Praca Magisterska. Katowice: Wydział Transportu Politechniki Śląskiej. 2009. [In Polish]
12. Lyons, R.G. *Wprowadzenie do cyfrowego przetwarzania sygnałów*. Warszawa: WKŁ. 2006. [In Polish]
13. Burdzik, R. Wpływ prędkości obrotowej silnika na drgania przenoszone na konstrukcję pojazdu. In: *Zeszyty Naukowe. Transport*. Gliwice: Politechnika Śląska. 2011. No. 72. P. 13-23. [In Polish]
14. Konieczny, Ł. & Burdzik, R. & Śleziak, B. Usage Short Time Fourier Transform in identification of vehicle shock absorber technical conditions researched by force vibration method. *Transport Problems*. 2009. Vol. 4. No. 3. Part 1. P. 71-77.
15. *Programming Resources - Phidgets Support*. Available at: [http://www.phidgets.com/docs/Programming\\_Resources](http://www.phidgets.com/docs/Programming_Resources)
16. Wilk, A. & Figlus, T. Influence of design and operations factors on vibroactivity of gearbox. In: *X International Technical Systems Degradation Conference. TSD International Conference*. Liptovsky Mikulas, 27-30 April, 2011.
17. *Phidgets Inc. - 1056\_0 - PhidgetSpatial 3/3/3*. Available at: [http://www.phidgets.com/products.php?product\\_id=1056\\_0](http://www.phidgets.com/products.php?product_id=1056_0)