

## Construction similarity in the process of creating ordered construction families

**P. Gendarz\*, R. Rząsiński, D. Rabsztyn**

Institute of Engineering Processes Automation and Integrated Manufacturing Systems,  
Silesian University of Technology, ul. Konarskiego 18a, 44-100 Gliwice, Poland

\* Corresponding e-mail address: piotr.gendarz@polsl.pl

Received 06.12.2013; published in revised form 01.03.2014

### ABSTRACT

**Purpose:** Theory of construction similarity has its roots in the theory of physical similarity. The model in the theory of construction similarity is a model construction. Model in the theory of similarity of construction and technology is construction and technology standard.

**Design/methodology/approach:** The fundamental aim of the work is the selection of design features in particular type sizes of series of types that allows obtaining physical, stereomechanical and simple states that are identical as in the model construction. The basic form of the record of series of construction types is program and relation parameterization. Features are determined for the items stored in the form of series of construction and technology types.

**Research limitations/implications:** Analysed methods develop algorithmisation of engineers and technologists environment and support integration with the process of preparation the production.

**Practical implications:** Described methods were being developed on practical examples of creating the series of types of hydraulic cylinders used in mining.

**Originality/value:** Method of the constructional similarity, technological similarity presented in the paper are basis of selection of design features in the process of series of types and module systems of constructions and technology creating. All of these methods support intensive development of the types of technical features and affect on their competitive on the ready market.

**Keywords:** Constructional design; Series of types; Module system; Theory of similarity

**Reference to this paper should be given in the following way:**

P. Gendarz, R. Rząsiński, D. Rabsztyn, Construction similarity in the process of creating ordered construction families, Journal of Achievements in Materials and Manufacturing Engineering 63/1 (2014) 19-29.

### ANALYSIS AND MODELLING

#### 1. Introduction

The purpose of using the theory of construction similarity is creating the ordered construction family such as series of construction types on the basis of the model

construction Fig. 1. As far as market economy is concerned, to construct means not only to develop one construction of technical measure, but it is advised to create a collection of constructions encompassing a wide range of demands for the specific class of technical measures [1,6,10,15]. The

idea of manufacturing, for instance, drawbar eyes bearing only the load of  $P=4$  kN, with the rod or piston diameter of  $d=M16$  and the diameter of the hole for the coupling pin in the drawbar eye of  $D=16$  mm, Fig. 1, would result in a very little interest in such product. On the other hand, when we create the ordered construction family in the form of series of types of the drawbar eyes, for the set of demands identified by the unified characteristic features with the value range of:  $P=0.9-8$  kN,  $d=M5-M30$ ,  $D=5-30$  mm, this will contribute to higher chances of acquiring a client and better adjustment to the client's needs, which also leads to better possibilities of staying on the competitive market. Therefore, it is justified to develop the construction methods, where on the basis of one construction a rational series of types with fixed construction form but variable dimension values is created. On that basis, quantitative and qualitative aspect comes down to the quantitative aspect, which means the problem of selecting the optimal values of dimensions  $w_{ij}^{c_j}$  ( $j = 1, jz$ ) for the characteristic features  $cch_{ic}^u$ .

This assignment, in the process of creating ordered construction families (series of types, modular construction systems) was called assignment  $\gamma$  [4],

$$cch_{ic}^u \rightarrow w_{ij}^{c_j} (j = 1, jz) \tag{1}$$

In the construction similarity based method of creating ordered construction families, we distinguish the following stages:

- selection, verification and modification of the model construction,
- unification and parameterization of the ordered construction family,
- construction record with the open dimension layout,
- creating the conditions of parameters and dimensions similarity,
- calculation and verification of the dimension values of the elements series of types,
- parametric construction record.

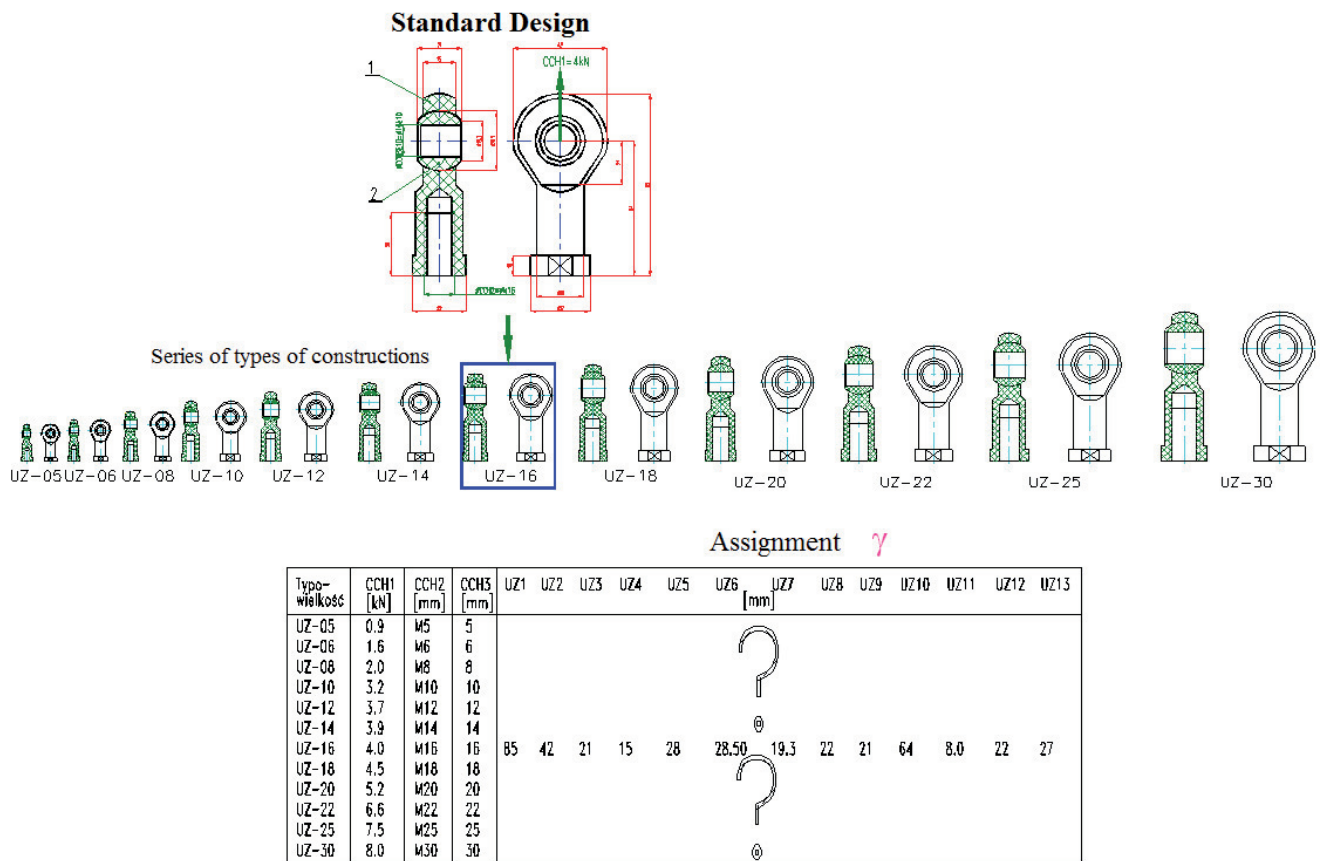

Fig. 1. A series of construction types created on the basis of the model construction

## 2. Model construction

A model construction ( $ks_0$ ) is a construction practically verified in terms of its behaviour (CAD simulation) and subject to optimization (particularly CAE strength optimization) that was verified due to the production (technology was developed in CAM) and the obtained product was subject to experimental verification (prototype tests). The construction may be accepted as the model construction once its respective product successfully meets the criteria of the experimental verification [5,9]. Due to the accuracy of calculations of dimension values using the construction similarity method it is advised to take the model construction from the mid-range of the ordered parameter values. It is possible to distinguish two ways of creating model constructions:

- criteria-based selection from the collection of the existing constructions, that has already been the basis for production and the produced technical measures satisfied the performance criteria,
- using the variational analysis for the newly created model construction.

In the first case, the purpose of selecting the model construction is mainly specialization and extending the range of the products and the demand for a given class of technical measures. First, the practical evaluation of the existing construction solutions is undertaken by the experts representing designers, construction engineers, technologists, economists, manufacturers, users and renovation specialists. Based on their opinions, it is possible to make the optimal choice or to modify the construction by creating the model construction  $ks_0$ . The example may be the chosen model construction forms of glands used in hydraulic cylinders in the mining industry, Fig. 2a. The result of the criteria-based evaluation and selection are the construction solutions for glands, Fig. 2b.

Applying the identical approach for the remaining systems of the cylinder, it was possible to create model construction forms of the hydraulic cylinders, Fig. 2c.

A special tool for creating a model construction for the newly created ordered construction family (preceding assignment) is using the Variational Analysis [4,7] developed, for instance, in the advanced graphic software I-DEAS. The variational analysis uses the finite element method that is additionally extended by:

- sensitivity analysis – relevant dimensions of the elements are chosen due to their strain and deformation conditions and mass,
- parametric analysis – optimal values are determined for the preset value ranges of relevant dimensions due to: not exceeding the permissible strains, not exceeding the

permissible displacement and deformation and the minimum mass.

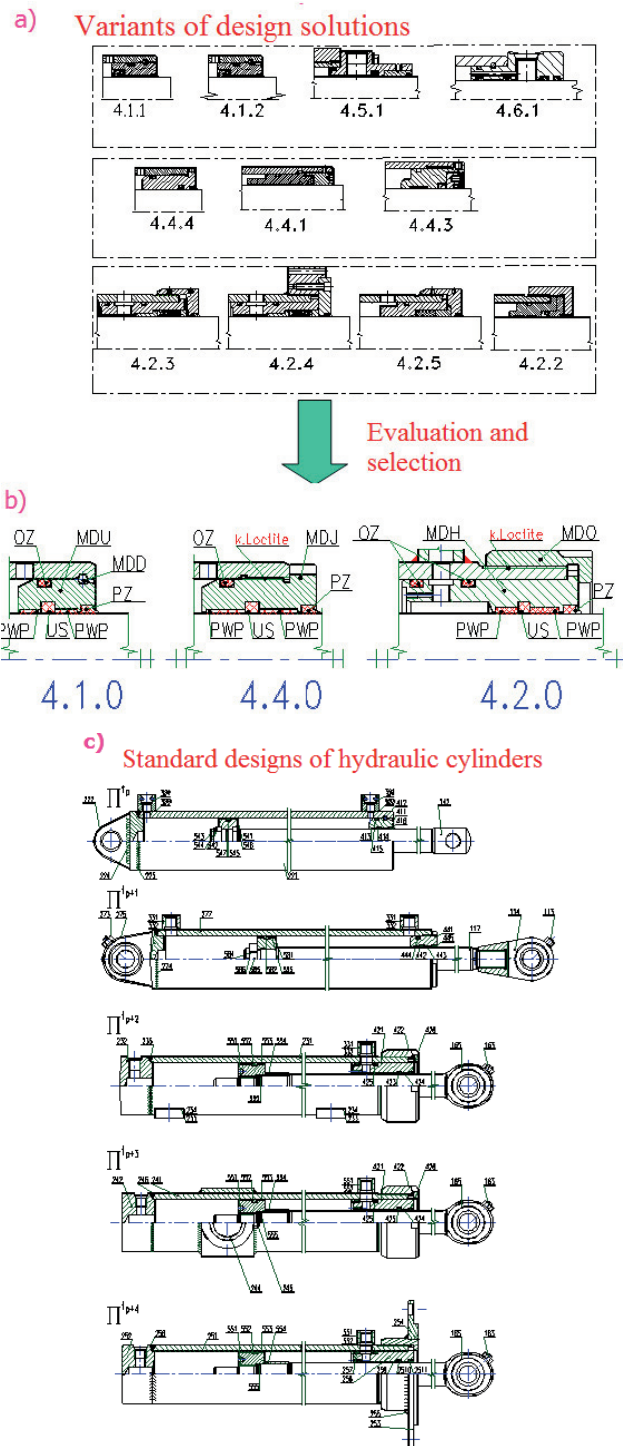

Fig. 2. Creating model constructions of the hydraulic cylinders in the mining industry

The example of applying variational analysis is creating the model construction of the gripping bit of the gripper. The initial model is presented in Fig. 3a; on the basis of the results of the variational analysis, as in Figs. 3b and 3c, the optimal model construction was obtained as presented in Fig. 3d.

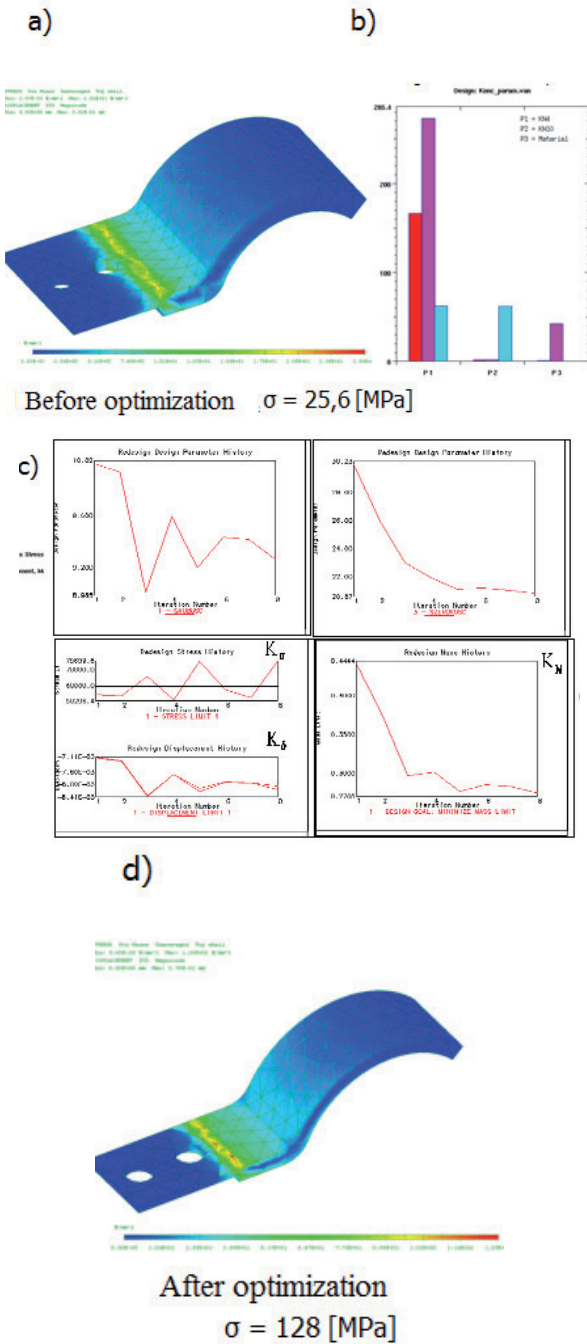

Fig. 3. Variational analysis of the gripping bit construction

In the model construction, greater criteria strain (not exceeding the limit strains) was allowed. On that basis, the element mass was reduced by 65%.

Another tool helpful in the process of creating newly created ordered construction family is the use of the topology optimization [2,11] based on the finite element method.

Topology optimization defines a way of distributing material in the designer – or engineer-defined domain of the entry model in a way that allows the optimal topology of the model element for the preset load and restraint conditions [12]. This process involves searching the maximum or minimum value of the objective function simultaneously fulfilling a certain number of specified conditions. In machine construction, optimization of the construction form is usually performed with regard to minimizing the capacity (mass), maximizing stiffness, maximizing material strength or searching for maximum frequency of natural vibration. Optimization process is carried out in the domain that does not change in time of the process and where domains with and without the material are created. The final effect of the process is the optimum distribution of material in the defined domain of the entry model (permissible domain). Finite elements are treated as single material points that need to be removed or whose nodes should be repositioned in the certain direction in a given step of the optimization process. A number of removed or repositioned finite elements depends on current process parameters. Division into finite elements is done once for the whole domain of the entry model. Two variables are updated in the process: density and Young module of finite elements. FEM-based optimization process is an iteration process, because the boundary value problem is solved a number of times and the material points (mass) are repositioned to the domains, where material strength is greater. The result of the process is a construction form created of finite element mesh that optimally satisfies the established criteria [13,14]. Selected stages of the topology optimization process using FEM is shown in Fig. 4.

Using topology optimization, the element mass was reduced by 17% (without exceeding the defined criteria of the process).

A received construction form usually requires modification due to the criteria resulting from the manufacturing capabilities, ergonomic and operating criteria. However, it should be remembered that due to errors in the FEA method [16], results of the topology optimization can only be treated as a good suggestion how to distribute the material in order to improve the use of model surface in view of the selected criteria.

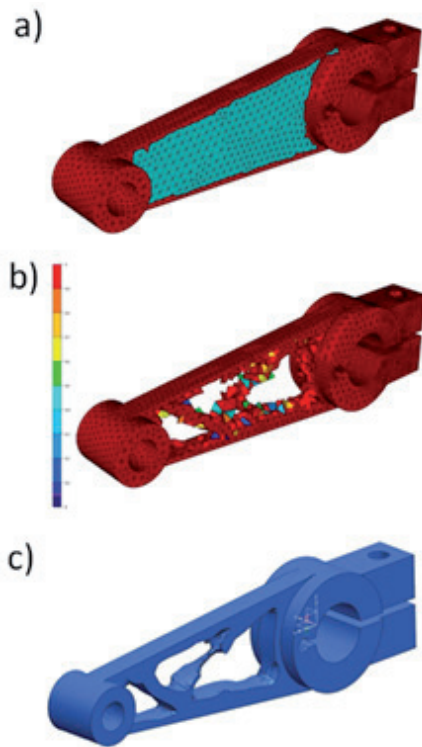

Fig. 4. Selected stages of the topology optimization process: a) defining the domain subject to optimization, b) results of the optimization process in the form of finite element model, c) CAD model of the optimum construction form

### 3. Construction unification and record with open dimension layout

Due to the record formalization, quantitative characteristic features have been distinguished from the set of characteristic features  $CCH_c^u$  that are called construction family parameters  $Pa_a^u; (a = 1, az)$ .

Parameter matrix constitutes independent variables for the purposes of determining quantitative elements construction features. The selection of the element construction features is made due to the demand, represented by the line of matrix parameters called unified parameters.

Due to the parameter values, quantitative construction features (geometry and material-related dimension values) are selected for particular manufactured elements. Construction family demand is described by the unified parameter values, i.e. limited and ordered parameter values set as binding for the specific period of time. Tools aiding

the process of creating unified parameters are: forecasting, adjusting the parameter values to the series of normal numbers, adjusting the parameters to the parameters of the interacting technical measures. An example of the unified parameters of the hydraulic cylinder is presented in Fig. 5, as independent variables of the assignment  $\gamma$ . Assignment  $\gamma$  precedes the assignment  $\beta$ , which involves decomposing the typical construction solutions by creating typical construction forms of the elements together with dimension layouts. In the dimension layout, variable dimensions take the letter and numerical designation, for instance for the element MTG – designation TG1 – TG15, Fig. 4.

### 4. Construction similarity conditions

A method of selecting dimension values on the basis of construction similarity has its roots in the theory of physical similarity. Physical models were constructed in the appropriate scale and subject to tests by simulating complex physical phenomena. On that basis, new constructions of technical measures were created. For example, by testing the model of a plane (made in the appropriate scale) in the aerodynamic tunnel it was possible to modify the geometrical construction form of the nacelle and its dimension proportions.

In the process of creating ordered construction families using the theory of construction similarity, the model corresponds with: model construction  $ks_0 \{y_{oi}^{e_j}; (i = 1, lv_j)(j = 1, jz)\}$  together with model parameters  $\bar{X}_0 \{x_{0a}; (a = 1, az)\}$ . They are used as a basis for the geometrically similar constructions  $ks_1 \{y_{il}^{e_j}; (i = 1, lv_j)(j = 1, jz)\} \in RK_n$ , with respect to the unified parameters  $\bar{X}_i^u \{x_{ia}^u; (i = 1, iz)(a = 1, az)\}$ , satisfying the criterion of the identical nature of feedback and transformation relations, Fig. 6.

Two fundamental numbers of similarities between the features of the new construction  $ks_1$  and model construction  $ks_0$  were defined:

- parameter similarity:

$$\varphi_a^u = \frac{x_{ia}^u}{x_{0a}}, \tag{2}$$

- dimension similarity:

$$\varphi_l^{e_j} = \frac{y_{il}^{e_j}}{y_{oi}^{e_j}}. \tag{3}$$

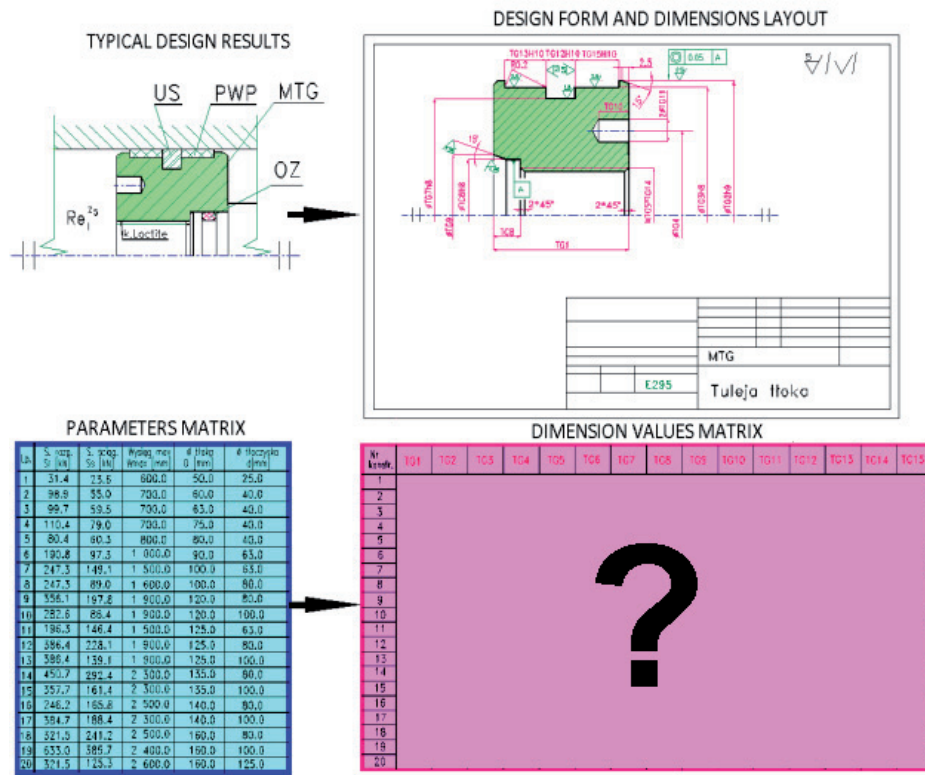

Fig. 5. Assignment  $\beta$  and  $\gamma$

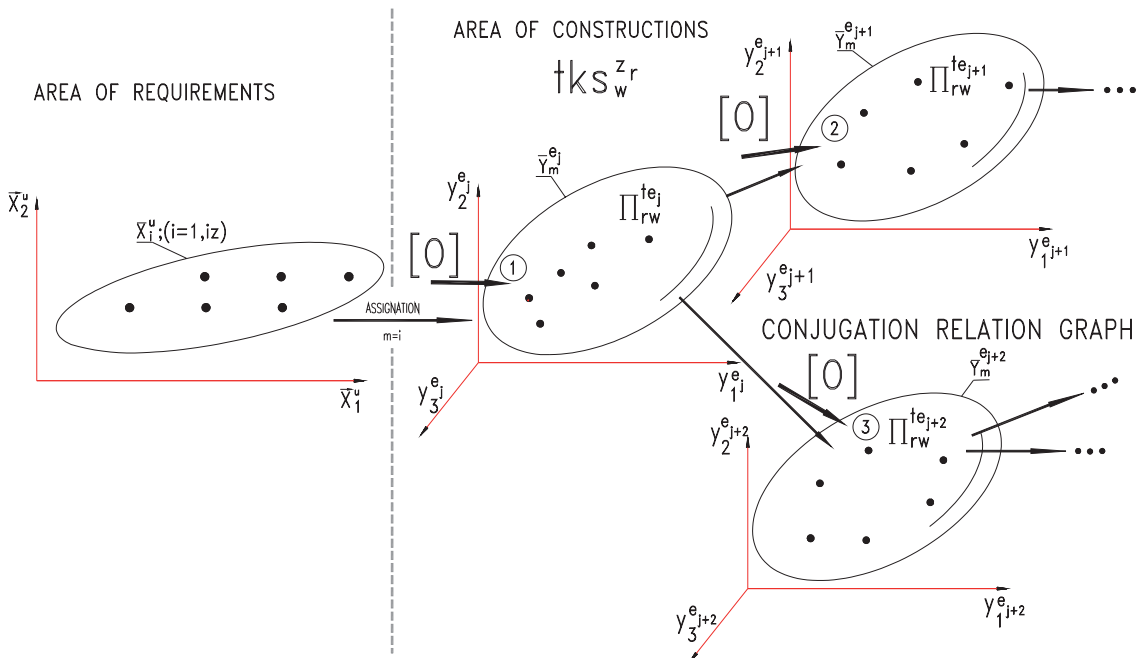

Fig. 6. Model of selecting quantitative construction features on the basis of the construction similarity

In the theory of construction similarity, we aim at such selection of construction features that allows obtaining the relation of systems feedback and transformation (Fig. 7a) in the new construction that are the same as in the model construction, therefore creating optimally diversified construction collections. Isomorphic relations of feedbacks and transformations distinguished in the system structure of the construction family are assigned to the phenomenological models and physical dependencies that are described in the form of mathematical functions, Fig. 7b. These functions are the basis for the selection of construction features  $y_{il}^{tej} (l = 1, l_{vis}) = f_p(x_{ia}^u)$ .

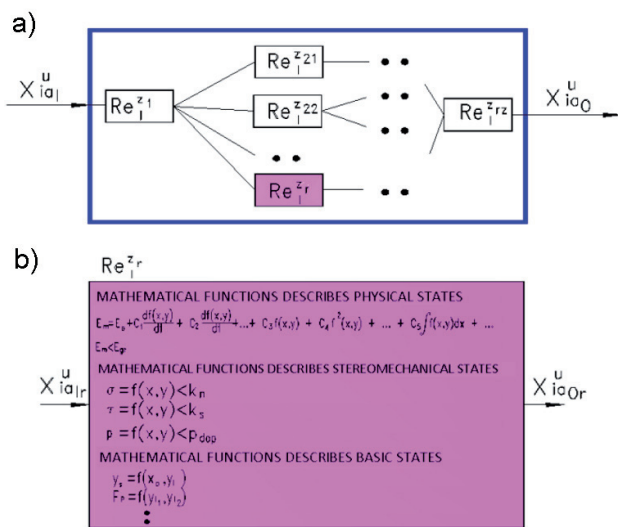

Fig. 7. Mathematical description of the states of the future technical measure

Retaining the identical nature of physical, stereomechanical and simple states described by means of the mathematical functions for the particular relations of system structure of the construction family, the construction similarity conditions are created.

Construction similarity numbers for the specific construction numbers concerning: force  $\varphi_F$ , torque  $\varphi_{M0}^u$ , surface  $\varphi_A$ , capacity  $\varphi_V$ , strength index  $\varphi_W$ , mass moment of inertia  $\varphi_j$  etc. are determined in the function of dimension similarity  $\varphi_1$ .

On the other hand, construction similarity numbers  $\varphi_1$  concern quantitative construction features assuming the fixed construction form  $\Pi$ . An example of acquiring the assumed similarity of the cross section area  $\varphi_A$ , for instance

for the square with a side length of 1 and side length similarity  $\varphi_1$  is as follows,

$$A = 1^2, \varphi_A = \left(\frac{1_i}{1_0}\right)^2 = \varphi_1^2 \tag{4}$$

Dependency (4) also applies to other cross sections: rectangle, ellipsis etc. assuming the steady increase of all dimensions, which means the complete dimension similarity. The condition of cross section area similarity means that, for example, changing the diameter of the shaft  $\varphi_1 = 2$  twice would result in a fourfold increase in the value of shaft diameter,  $\varphi_A = 4$ .

Generalizing, the following dependencies may be observed, Table 1.

Table 1. Fundamental dependencies between similarity numbers

Similarites number of size	Symbol	Number of similarity dimension
Rotation speed	$\varphi_n$	$\varphi_1^{-1}$
The angular velocity	$\varphi_\omega$	
Linear speed from	$\varphi_v$	
Static forces:		
Relative elongation,		$\varphi_1^0 = 1$ , ie. const
Stresses	$\varphi_\sigma, \varphi_p$	
Surface pressure		
Elastic elongation, the stiffness of the spring.	$\varphi_{\Delta l}, \varphi_c$	
Since the forces of gravity:		$\varphi_1^1$
relative elongation	$\varphi_\epsilon$	
stresses, surface pressure	$\varphi_\sigma, \varphi_p$	
Static forces	$\varphi_F$	$\varphi_1^2$
Surface area	$\varphi_A$	
Volume	$\varphi_V$	
Weight	$\varphi_G$	
Torque	$\varphi_{M_s}$	$\varphi_1^3$
Axial and polar section modulus	$\varphi_{W_x}, \varphi_{W_0}$	
The surface moment of inertia.	$\varphi_{I_x}, \varphi_{I_0}$	$\varphi_1^4$
Mass moment of inertia.	$\varphi_{J_x}$	$\varphi_1^5$

The basic state of the new construction, that should be the same as in the model construction, is the stereomechanical state understood as the identical nature of the strains  $\varphi_\sigma = 1$ . Considering the simple state of extending the element with static force F (excluding the

dead weight), strains are determined using the following formula,

$$\sigma = \frac{F}{A} \leq \sigma_{dop}, \quad (5)$$

The number of strain similarity in the series of types (modular series) is calculated as follows,

$$\varphi_{\sigma} = \frac{\sigma_i}{\sigma_0} = \frac{F_i \cdot A_0}{F_0 \cdot A_i} = \frac{\varphi_F}{\varphi_A} = \frac{\varphi_F}{\varphi_1^2} = 1, \quad (6)$$

hence

$$\varphi_F = \varphi_1^2. \quad (7)$$

Parameter values, as well as values of elements quantitative construction features, on the basis of construction similarity conditions, parameters and dimensions of model construction, may be calculated according to the following formula:

- unified parameter values:

$$x_{ia} = x_{0a} \cdot (\varphi_{11}^u)^i \quad (8)$$

- dimension values:

$$y_{il}^{c_j} = y_{0l}^{c_j} \cdot (\varphi_{11}^{c_j})^i \quad (9)$$

where:

$x_{0a}$  – value of the a model parameter,

$y_{0l}$  – value of the l dimension of the model construction,

i – value of the exponent defining the distance from the model construction (taking the values  $i = \dots -2, -1, 0, 1, 2, \dots$ , where value  $i=0$  – corresponds to the model construction).

Parameter and dimension values may be calculated, as presented above, analytically or graphically using nomograms with coordinates in the logarithmic scale.

The results are the dimension values obtained on the basis of construction similarity that were additionally modified to match the dimensions of catalogue and normalized elements. Dimension values of the piston bush presented in Fig. 8 may serve as an example.

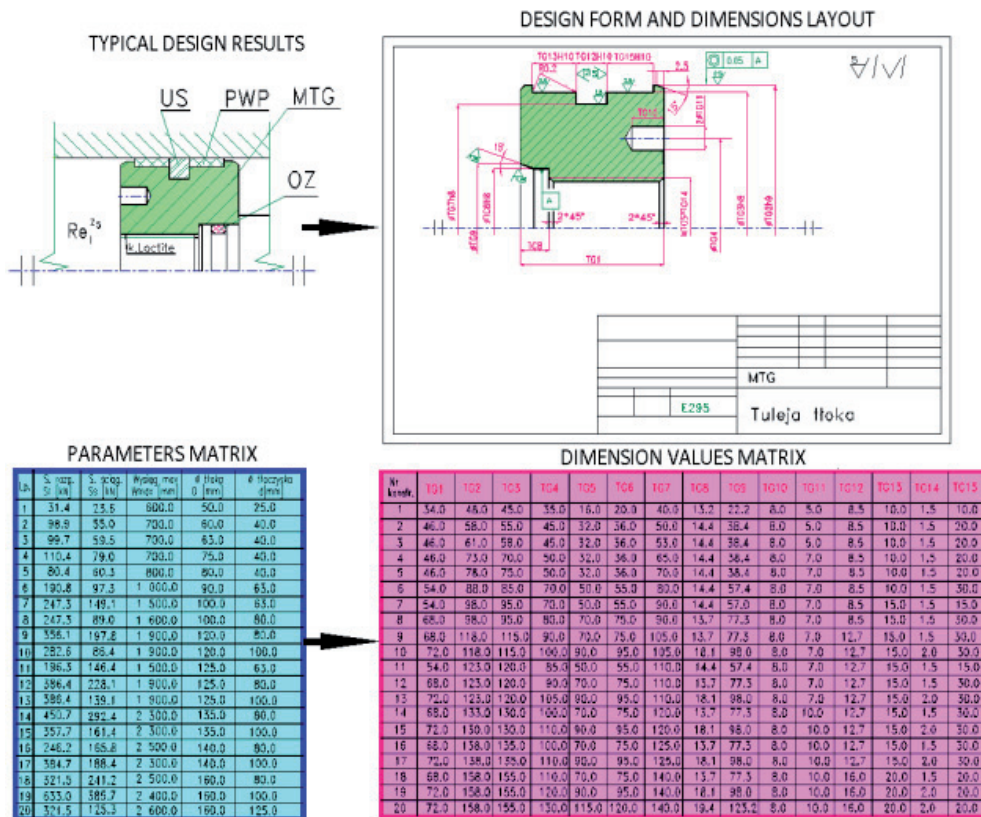

Fig. 8. Result of the assignment gamma



## 5. Parametric construction record of series of types

Parameterization is a specific form of construction record, adapted to the record of series of construction types (modular series) that are characterized by fixed construction form *II* and variable dimension values *W*. Graphic programs distinguish a few types of parameterization: dynamic, relation, program and graphic parameterization.

In the process of creating ordered construction families using construction similarity method, the best results were achieved applying program and relation-graphic parameterization.

Program parameterization uses programming language and graphic software, where this language is used, such as AutoLISP programming language in the graphic software AutoCAD. Element construction record comes down to identifying the coordinates of the characteristic points of the record, Fig. 9. Coordinates of the characteristic points are determined in the function of variable dimensions  $TG_1$  and calculated on the basis of model construction dimension values. Generally, it may be presented as follows:

$$\langle x_n, y_n \rangle = f(y_{il}^{te_j}) \quad (10)$$

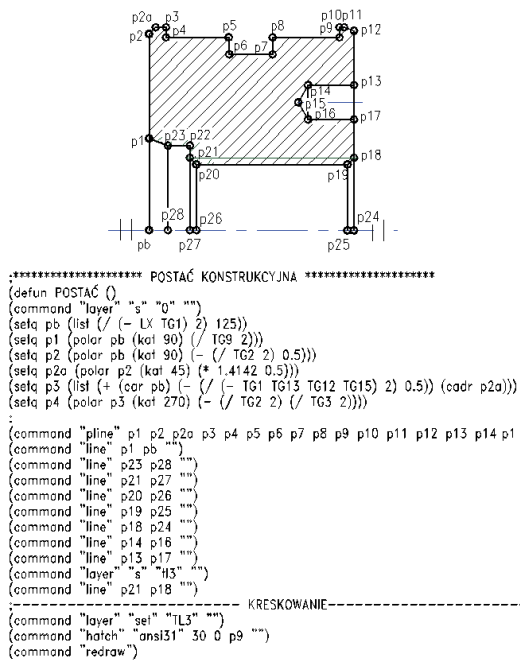

Fig. 9. Parametric record of the MTG element

Calculating the coordinates of points begins with so called index point. If the figure presents more cross sections (views, partial views, cross sections, partial cross sections), then there are also more index points. Coordinates of index points determine the position of the projections on the sheet and may be designated using the adopted sheet format and drawing scale. Moving from the index point, point by point, we determine the coordinates of record characteristic points for a given projection in the dimension function. Starting parametric record in the graphic program, we obtain the record of the construction of a chosen type sizes of the element in the form of the execution drawing.

In the relation-graphic parameterization, an equation editor was used to determine the values on the basis of the relations (8) and (9), Fig. 10, whereas dimensions with incomplete similarity or fixed were saved in the form of a table. On that basis, catalogues of elements type sizes were formed allowing generating 2D and 3D construction documentation of technical measures depending on the chosen variant of the construction solution and parameters.



Fig. 10. Editor with construction similarity conditions and 3D models of types sizes

## 6. Technological similarity

Technological similarity is applied in the process of defining technological features to generate the parameters of processing.

Those parameters concern the processes of machining: turning, hole making, milling. For series of types of technology for one selected technology the parameters of process are calculated. They are being calculated by: algorithms, analytical programmes, norms. The parameters defined as standard parameters (technological features) are selected on the basis of constructional features [8].

The theory of technological similarity is applied for elements characterized by constant constructional form and variational values of dimensions

Standard structure is used to generate further technological structures by modification of chosen parameters. The selection and transformation of parameters is realized after having defined the system of relations and the system of connections and transformations between individual features. It is important that this method is applied to create technological documentation for series of types of elements. It is characteristic for all series of types of elements to have constant constructional form of all elements. Constructional features (dimensions) are variable.

The process of technology ordering is realized for series (Equation 11) or module series (Equation 12, applying them in identical possible operations, cuts, parameters of processing, seizing, tools, gears.

$$tS_m^{te^j}; (m = 1, mz_j) \quad (11)$$

$$mk_m^{rwe^j}; (m = 1, mz_j) \quad (12)$$

Considering the series of types elements manufactured ( $KS_n^{te^1} (n = 1, nz)$ ,  $KS_n^{te^2} (n = 1, nz)$ ,  $KS_n^{ten} (n = 1, nz)$ ).

The plans of production on basis of constructional form of unit are created. Plans can be presented in form of variants of solutions plan production ( $VPW_1^{el1}$ ,  $VPW_0^{el2}$ ,  $VPW_i^{el1}$ ). These plans of production are also the object of optimization for each series of construction, and the typical plans of production are the final result  $PW_0^{el}$ .

The next stage is the creation of qualitative features of technology, which includes the selection of a typical:

- technological form  $\Gamma_s$ ,
- form of semi-finished product  $\Gamma_{pf}$ ,
- form of tools  $\Gamma_n$ .

The selection of quantitative features begins with the technological determination of these features for the technology standard.

The next stage of the method includes creating the conditions for technological similarity. Are the basis of technology to maintain identical conditions for the entire range of technology created. On the basis of conditions similarity are determined technological parameters of another technological components ( $Te_n^{te^1} (n = 1, nz)$ ,  $Te_n^{te^2} (n = 1, nz)$ ,  $Te_n^{ten} (n = 1, nz)$ ).

### 6.1. Condition of technological similarity

This paper analyses the similarity of constructional parameter (entrance data presenting constructional quantitative feature, marked as pi) and the similarity of parameter of processing (exit data presenting the quantitative parameter of process, marked as w<sub>i</sub>).

- similarity of constructional parameter,

$$\varphi_{ik} = \frac{P_{ik}}{P_{0k}}, \quad (13)$$

- similarity of parameters of processing,

$$\varphi_{it} = \frac{w_{ik}}{w_{0k}}. \quad (14)$$

The generalized model of transformation of selected constructional features (quantitative):

#### 1. Mathematical functions describing technological states:

$$Q = v_c \cdot a_p \cdot f \quad (15)$$

$$F_c = R_m \cdot A_w \quad (16)$$

$$P_c = \frac{v_c \cdot a_p \cdot f_n \cdot k_{c0,4}}{240 \cdot 10^3} \quad (17)$$

#### 2. Similarity conditions resulting from assumed technological states:

$$\varphi_{Pc} = \frac{P_{ci}}{P_{c0}} \quad (18)$$

$$\varphi_{Pc} = \varphi_{V_i} \cdot \varphi_{a_{pi}} \cdot \varphi_{f_{ni}} \cdot \varphi_{k_{c0,4i}} \quad (19)$$

$$\varphi_{Qc} = \frac{Q_{ci}}{Q_{c0}} \quad (20)$$

$$\varphi_{Qc} = \varphi_{R_m} \cdot \varphi_{a_p} \cdot \varphi_{f_n} \quad (21)$$

$$p_c = 1 \quad \varphi_Q = 1 \quad \varphi_{Fc} = 1$$

## PROCESS OF TRANSFORMATION

equation of similarity:

$$\varphi_{V_i} \cdot \varphi_{a_{pi}} \cdot \varphi_{f_{ni}} \cdot \varphi_{k_{c0,4i}} = 1 \quad (22)$$

### 3. The conditions of similarity describing dimensions of similarity for parameters of processing

$$pa_{a_{pi}} = pa_{a_{p0}} \cdot \left( \frac{1}{\varphi^2} \right)^i \quad (24)$$

$$v_i = v_0 \varphi^i \quad (23)$$

$$f_{n_i} = f_{n0} \cdot \varphi^i \quad (25)$$

for  $i = -7, -6, \dots, 0, \dots, 6, 7$

where:

$i$  – number of element of series of type,

$\varphi$  – number of similarities.

In the paper the transformation of the quantitative constructions features (dimension) into quantitative features of technology (technological parameters) with the assumption of constant qualitative features in considered domain is proposed. On the basis of elaborated technological processes the following stages of creating the ordered family of technology on the basis of ordered construction. According to defined measures of similarity value of parameters of processing are specified according to constant technological or constructional states.

The values of parameters are generated one after another using following elements: constant power machining, solid efficiency of processing or strength of cutting. Construction similarity numbers for the specific construction numbers concerning: force, torque, surface, capacity, strength index, mass moment of inertia etc. are determined in the function of dimension similarity.

The obtained values of parameters should be optimized into the range of applicable values.

### Acknowledgements

This work has been conducted as a part of the research project N N502 087638 supported by the Ministry of Science and Higher Education.

### References

- [1] W. Beitz, G. Pahl, Construction science, WNT, Warsaw, 1984 (in Polish).
- [2] M.P. Bendsoe. O. Sigmund, Topology optimization. Theory, Methods and Applications, Springer, 2003.
- [3] M. Cielniak, Verification of the constructional similarity theory on composite elements example, Mechanical Overview 12 (2013) 17-21 (in Polish).
- [4] M. Cielniak, Optimization using FEM in NX program. STAL. Metals & New Technologies 7-8 (2011) 63-66 (in Polish).
- [5] M. Cielniak, The automation of manufacturing costs estimation process, Selected Engineering Problems 3 (2012) 41-46.
- [6] P. Gendarz, R. Rzański, Project of a trenchless works tunneling machines ordered construction family, Journal of Achievements in Materials and Manufacturing Engineering 33/2 (2009) 181-188.
- [7] P. Gendarz, P. Chyra, R. Rzański, Constructional similarity in process of ordered construction families creating, Journal of Achievements in Materials and Manufacturing Engineering 29/1 (2008) 53-56.
- [8] R. Rzański, The theory of similarity in turning operations, Journal of Achievements in Materials and Manufacturing Engineering 53/1 (2012) 37-46.
- [9] P. Gendarz, D. Rabsztyń, The exemplar design features in creation of the series of types, Journal of Achievements in Materials and Manufacturing Engineering 55/2 (2012) 488-497.
- [10] J. Dietrych, System and construction, WNT, Warsaw, 1985 (in Polish).
- [11] A. Kania, M. Spilka, Optimization as an alternative in search of sustainable technological processes, Journal of Achievements in Materials and Manufacturing Engineering 17/1-2 (2006) 413-416.
- [12] R. Kutyłowski, Topology optimization of physical continuum, Publisher of Wrocław University of Technology, Wrocław, 2001 (in Polish).
- [13] K.E. Oczóś, Lightweight structures – types, implementation and application. Part. 1, Mechanic 4 (2011) 271-275 (in Polish).
- [14] K.E. Oczóś, Lightweight structures – types, implementation and application. Part. 2, Mechanic 5-6 (2011) 377-390 (in Polish).
- [15] Z. Osinski, J. Wróbel, Construction Theory, PWN, Warsaw, 1995 (in Polish).
- [16] T. Zagrajek, G. Krzesiński, P. Marek, Finite Element Method in mechanical design, Publisher of Warsaw University of Technology, Warsaw, 2006 (in Polish).