

The theory of similarity in turning operations

R. Rzański*

Institute of Engineering Processes Automation and Integrated Manufacturing Systems,
Silesian University of Technology, ul. Konarskiego 18a, 44-100 Gliwice, Poland

* Corresponding e-mail address: rafal.rzasinski@polsl.pl

Received 23.05.2012; published in revised form 01.07.2012

Analysis and modelling

ABSTRACT

Purpose: The article presents the development of series of types of technology issues. This is an accomplished using of the innovative technological similarity theory. The transformation presented in the theory relates to the turning machining processes.

Design/methodology/approach: The data generation process is concerned with the creation of the conditions and number similarities. The turning condition of similarity results from the cutting power, cutting forces and cutting performance.

Findings: The development of the theory of similarity allows the generation of machining parameters for the series of types of construction (blank, machining parameters, tools).

Research limitations/implications: The analyzed methods develop the algorithmisation of engineers and technologists environment and support the integration with the process of preparation of the production.

Practical implications: The described methods were being developed on the practical examples of the creating of the series of types of the hydraulic cylinders used in mining.

Originality/value: The method of the technological similarity presented in the paper is the basis of the selection of technological features in the process of series of types and module systems of constructions and technology creating.

Keywords: Technological design; Series of types; Theory of similarity; Turning

Reference to this paper should be given in the following way:

R. Rzański, The theory of similarity in turning operations, Journal of Achievements in Materials and Manufacturing Engineering 53/1 (2012) 37-46.

1. Introduction

The similarity between the certain classes of technical resources has been used in the various fields of science for a long time [1,2,11].

Regardless how it is defined and which of the issues are concerned, it is associated with the comparison and identification of some new values based on the principles of similarity. A number of information related to the determination of this method is contained in the publications [3,4,9] and applies this approach in the various fields such as physics, chemistry, mechanics, construction, etc. The precursor of the method of similarity was Osborn Reynolds.

In this paper, the method of similarity is used in the process of the characteristics determining of integrated technology based on the design features of the treatment parameters to generate a series of types of technology. These parameters relate to methods of turning. For a series of types of technology for one of the selected technologies processing parameters are calculated in the traditional way and called the model parameters. These parameters as well as certain structural features determining the processing parameters will be used for other technologies series of elements according to the rules that have been developed for this method.

2. Stages and main methods

Data subject to algorithmization in the process of integrated transformation of technological parameters on the basis of the design characteristics are quantitative design features. Quantitative design features constitute the basis of the theory of technological similarity. Series of types of the elements have the constant form design for all elements but variable design features. This assumption allows the selection of quantitative features algorithmization technology (processing parameters). The whole

structure of the technology (type of treatment, surgery, treatments, transitions) allows to remain stability (or slight difference) for all elements of the series.

Construction can be adopted as the standard construction, when the corresponding product best met the criteria for experimental verification. The model shown in the Figure 1 is created on the basis of series of construction. The main theme of the consideration are series of types of elements :

$$KS_n^{te1} (n = 1, nz) \quad KS_n^{te2} (n = 1, nz) \quad KS_n^{ten} (n = 1, nz)$$

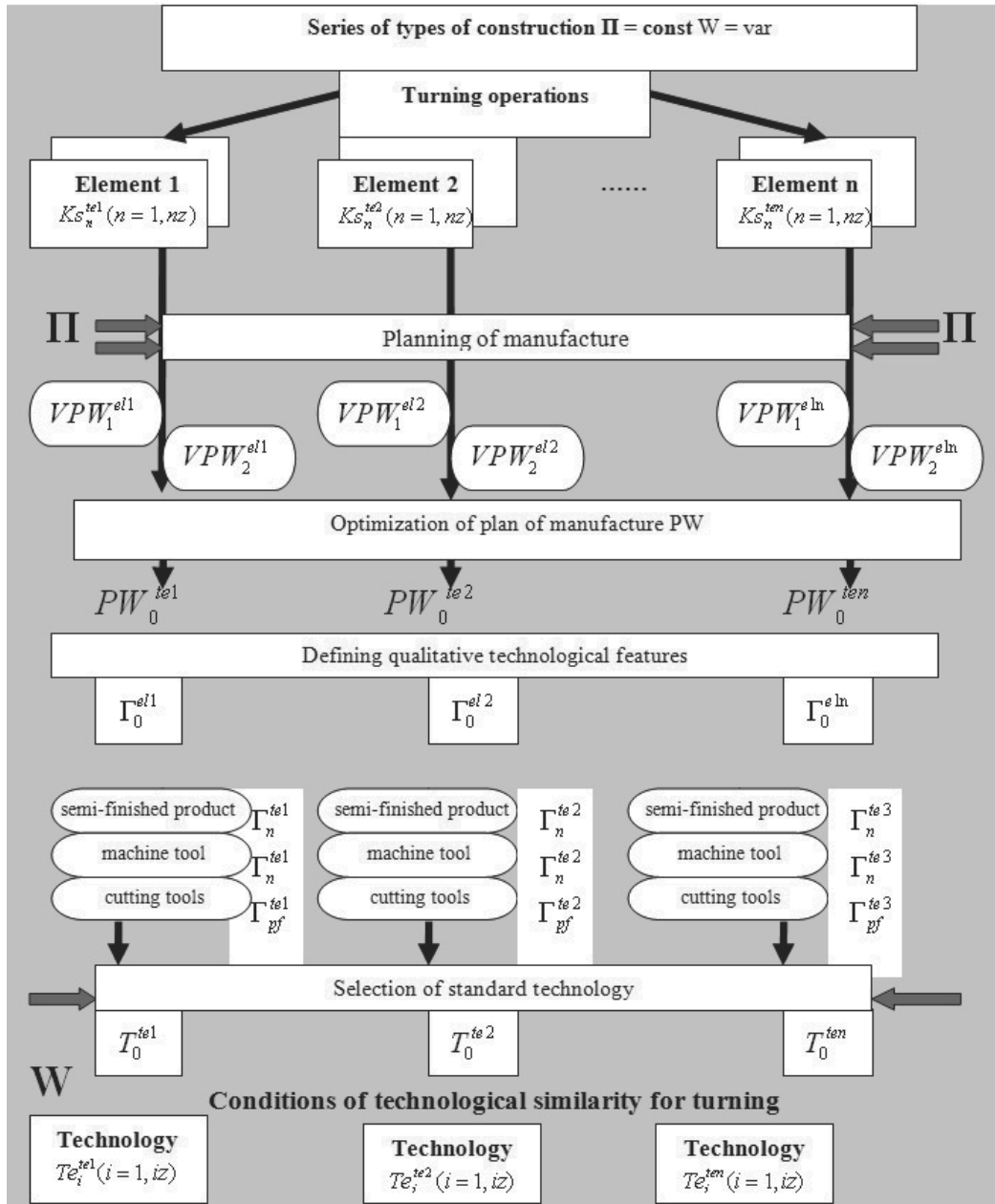

Fig. 1. A model of the selection technological features

The plans are created on the basis of a structural element of the production that can take the form of variants of solutions to the production plan (VPW_i^{el1} , VPW_0^{el2} , VPW_i^{el1}). Just set up production plans are subject to optimization for each design series. The results of the optimization are selected production plans PW_o .

The next stage is the methods creation of qualitative characteristics of technology, which involves the selection of a typical:

- technological structure Γ_s ,
- blank Γ_{pf} ,
- instrumentation Γ_n ,
- tooling Γ_o .

The selection of quantitative features of technology begins with the designation of these features for the technology standard. The next stage of the method includes creating conditions for technological similarities.

3. Standard technology

The standard technology provides an input to the transformation of both qualitative and quantitative features implemented in the framework of similarity theory of technology.

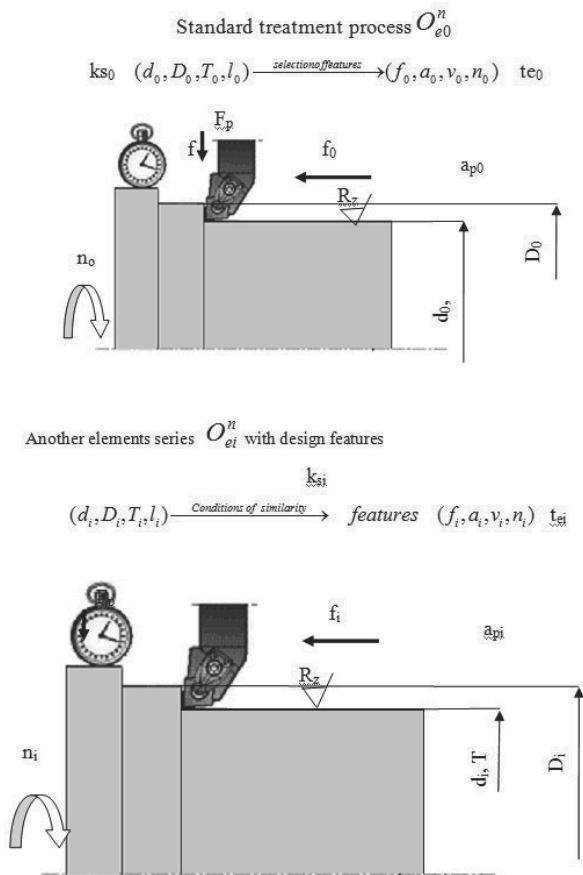

Fig. 2. The relationships between the standard features and calculation

where:

$f_0, a_0, v_0, n_0 / f_i, a_i, v_i, n_i$ - standard treatment parameters/ next (Search),

$d_0, D_0, T_0, l_0 / d_i, D_i, T_i, l_i$ - design features of the standard/ next series of types

That technology is defined for the selected designed technology (usually a structure located in the middle of the considered range of construction). It is necessary to determine the qualitative and quantitative characteristics of technology for this construction.

In this paper a quantitative model for the characteristics determination was used to developed the calculation program [7,8]. Qualitative characteristics of technology are created on the basis of the experience of technologists in accordance with guidelines technology [2,6,5]. For the standard technology the existing component technology is claimed. This is a form of practical verification standard technology adoption. The standard technology in this method influences on the correctness of generating technology for all element of series of types. The scheme of the transformation of standard features into technological features are presented in Fig. 2.

4. Similarity in turning operations

Turning processes are considered in terms of selection of appropriate processing parameters for different variations. Technological similarity theory applied to these issues will determine the characteristics of technology for the series of machined diameters (shafts or holes). This paper concerns the processing elements of series of types of actuators and hydraulic props (piston, piston rod, stuffing box). It is achieved by mathematically determining of the similarity of numbers for a given parameter processing. The process is considered for rough and finish turning operations (Fig. 3).

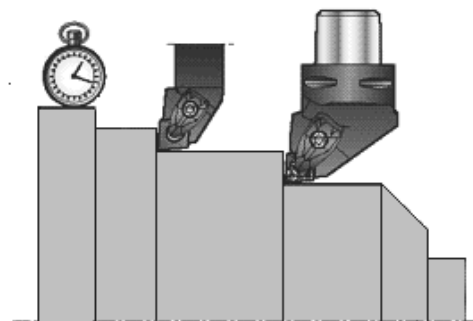

Fig. 3. The scheme for external turning

The declared certain standard technical features are derived from the conditions of similarity. The conditions of similarity are determined due to the three states united in the cutting force F , by power cutting P and metal removal rates Q . Master data to determine the characteristics of technology in the area of quantitative features are the structural features of the independent variables: geometric and materials.

Features range of construction series (input) are:

- diameter of the shaft d_i [mm],
- turning length l_i [mm],
- tolerance To_i ,
- workpiece material kc 0.4 [N/mm²].

where: i - the number of elements of series of types.

Technological features depend on the output characteristics features determined on the basis of the design characteristics (input) are:

- feeds f_i [mm / rev],
- cutting speed v_i [m / min],
- depth of cut a_{p_i} [mm],
- rotational speed n_i [r / min].

where: i - the number of elements of series of types.

Selection of machining parameters for turning processes is dependent [10]:

- requirements regarding the shape and position
- tolerances,
- strength tools,
- strength of the feed mechanism,
- requirements for surface roughness.

In this paper, these influences are translated into technological conditions on cutting forces by cutting and machining performance.

The correctness of calculated parameters is checked for the deformation of the cases shown in Figure 4. If the calculated deflection of the shaft of the parameter exceeds the established limit (tolerance of an element), change the parameter value or the value of similarity. In addition exactly the same tools and a knife shaft diameter from the condition is tested for flexural strength resulting from the selected cutting parameters.

4.1. Condition of technological similarity

Schematic transformation conditions resulting from the assumed constant technological conditions shown Figure 5. Presented are also the types of process considered turning machining.

Conditions resulting from the power cut

Cutting power value is calculated on the basis cut parameters, equations 1.

$$P_c = F_c v_c \quad (1)$$

where:

F_c -cutting force,
 v_c - cutting speed.

The number of similarities power cut φ_{Pc} is defined as the ratio of power P_{c_i} to standard cutting technology P_{c_0} ,

$$\varphi_{Pc} = \frac{P_{c_i}}{P_{c_0}} \quad (2)$$

Number of similarities technological parameters are determined from the dependence, equations 3.

$$\varphi_v = \frac{v_i}{v_0}, \quad \varphi_{a_p} = \frac{a_{p_i}}{a_{p_0}}, \quad \varphi_{f_n} = \frac{f_{n_i}}{f_{n_0}} \quad (3)$$

Finally, the similarity condition resulting from the cutting power can be saved in the form

$$\varphi_{Pc} = \varphi_v \varphi_{F_c} \quad (4)$$

According to the assumption of the method $\varphi_{Pc} = 1$, assumed the same cutting power for all range of technology. Finally, a condition resulting from the power cut has the form,

$$\varphi_{v_c} * \varphi_{F_c} = 1. \quad (5)$$

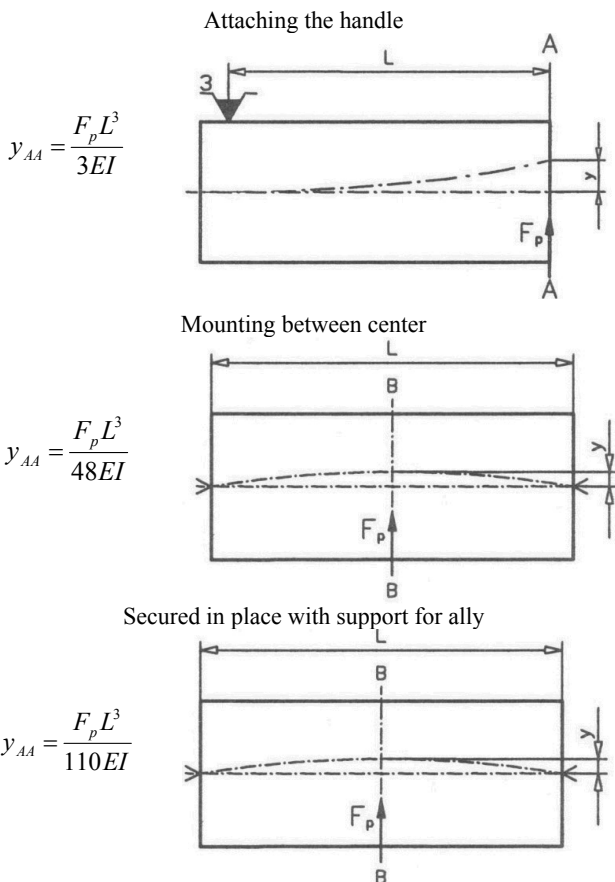

where: F_p - The force component in the work adopted, $F_p = 0.4 F_c$, E - Young module, I - moment of inertia ($I = \frac{\pi d^4}{32}$), y_{AA} - displacement

Fig. 4. The deflection of the shaft, depending on the mount [11]

Conditions resulting from the cutting forces

The value of cutting force is determined in accordance with the equation 6,

$$F_c = k_c A_w F_c, \quad (6)$$

where:

A_w - cross section of cutting $A_w = f_n * a_p$ [mm²],
 k_c - allowable stress to the workpiece.

The formula for taking into account the cutting force coefficients resulting from the treatment conditions takes the form:

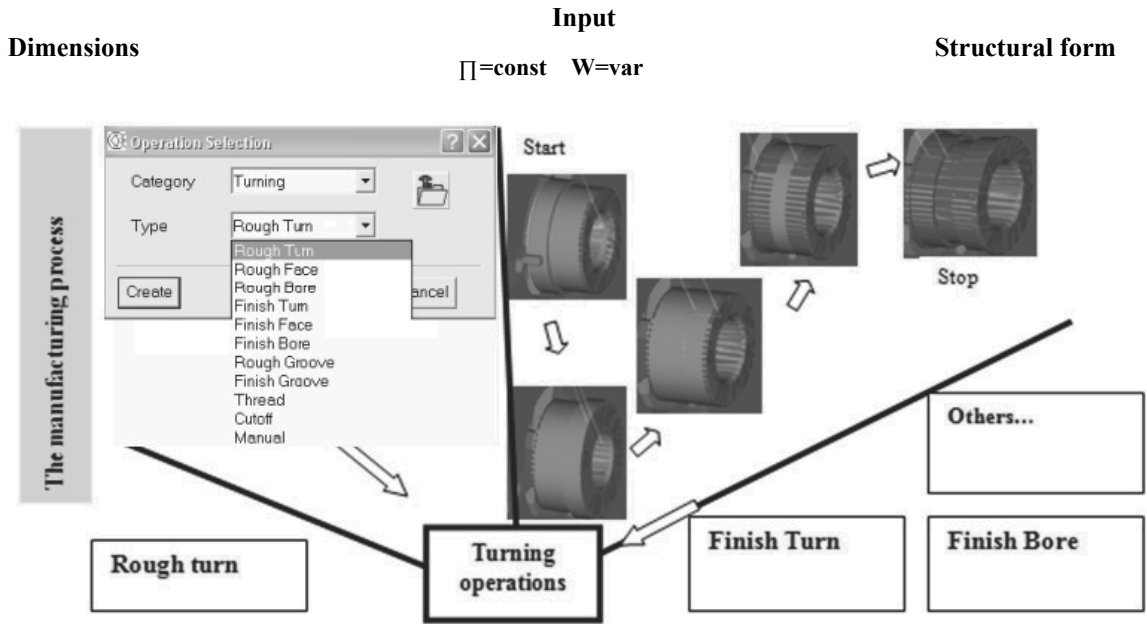

$$Q = D_c n f \pi a_p \text{ [cm}^3\text{/min]} \quad P_c = F_c v_c \text{ [W]} \quad F_c = a_p * f * k_c * K_{\gamma 0} * K_v * K_{sch} * K_{ver} \text{ [N]}$$

Number of similarities resulting from the assumed state of technology:

$$\varphi_{P_c} = \frac{P_{ci}}{P_{c0}} \quad \varphi_{Q_c} = \frac{Q_{ci}}{Q_{c0}} \quad \varphi_{F_c} = \frac{F_{ci}}{F_{c0}} \quad \text{Assumption: } \varphi_{P_c} = 1 \quad \varphi_Q = 1 \quad \varphi_{F_c} = 1$$

$$\varphi_{Q_c} = \varphi_{R_m} * \varphi_{a_p} * \varphi_{f_n} \quad \varphi_{F_c} = \varphi_{R_m} * \varphi_{a_p} * \varphi_{f_n} \quad \varphi_{P_c} = \varphi_{V_i} * \varphi_{a_{pi}} * \varphi_{f_{ni}} * \varphi_{k_{c0,4i}}$$

Parameter values for the standard technology

$$a_{p0} = \dots, f_0 = \dots, v_0 = \dots, n_0 = \dots$$

Global similarity conditions: $W1 = \dots, W2 = \dots, W \dots = \dots$

Determining the processing parameters

$$f_i = f_0 * \left(\frac{1}{\varphi}\right)^i \quad v_i = v_0 * \varphi^i \quad D_i = D_0 * \varphi^i \quad a_{p_i} = a_{p_0} * \varphi^i$$

where: i-element number of series, φ -number similarity

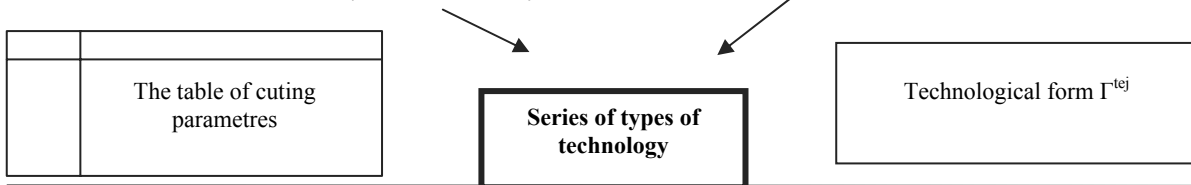

Fig. 5. Writing of transformation constructional in technological using similar technology for turning

$$F_c = a_p f k_c K_{\gamma_0} K_v K_{sch} K_{ver} [N], \quad (7)$$

where:

K_{γ_0} - Factor influencing the change in angle of attack,

$$K_{\gamma_0} = 1 - \frac{\gamma_0 - \gamma_{ok}}{66.7},$$

γ_0 - angle of attack,

γ_{ok} - angle of attack as measured kc,

K_v factor related to changes in cutting speed,

K_{sch} factor related to changes in the blade material,

K_{ver} - rate of wear of the blade.

The number of similarities is defined as the ratio of power F_{ci} to standard cutting technology F_{c0} ,

$$\varphi_{F_c} = \frac{F_{ci}}{F_{c0}} \quad (8)$$

We can assume:

- constant material, $\varphi_{kc} = 1$,
- no conversion tool geometry, $\varphi_{K_{\gamma_0i}} = 1$,
- constant cutting speed specified range of treatments, $\varphi_{K_{vi}} = 1$,
- no changes in cutting tool materials, $\varphi_{K_{schi}} = 1$,
- fixed tool life tool (only for a specified time), $\varphi_{K_{veri}} = 1$.

The condition after taking into account the above assumptions takes the form,

$$\varphi_{F_c} = \varphi_{a_{pi}} \varphi_{f_n}. \quad (9)$$

According to the assumption of the method $\varphi_{F_c} = 1$. Finally, a condition resulting from cutting forces has the form,

$$\varphi_{a_{pi}} \varphi_{f_n} = 1 \quad (10)$$

Conditions resulting from the cutting efficiency

Cutting performance is another condition that is considered for the selection of technological features. Cutting efficiency specified for the standard technological parameters is calculated from the dependence 11.

$$Q_c = D_c n f_n \pi a_p [\text{mm}^3/\text{min}], \quad (11)$$

where: D_c -diameter, f_n - feeds, a_p - depth of cut, n - spindle speed.

The number of similarities resulting from the cutting efficiency is defined as,

$$\varphi_{Q_c} = \frac{Q_{ci}}{Q_{c0}}. \quad (12)$$

After substituting dependency 11,

$$\varphi_{Q_c} = \frac{D_{ci} * n_i * a_{pi} * f_{ni}}{D_{ci} * n_0 * a_{p0} * f_{n0}} \quad (13)$$

After the substitutions and transformations we have,

$$\varphi_{Q_c} = \varphi_D \varphi_{a_p} \varphi_{f_n} \varphi_n. \quad (14)$$

According to the assumption of the method $\varphi_{Q_c} = 1$,

$$\varphi_D \varphi_{a_p} \varphi_{f_n} \varphi_n = 1 \quad (15)$$

Determination of the number of similarities with the above-derived conditions allow to determine the interchangeability of parameters for series of types on the basis of the standard technological features.

$$V_0(we) \xrightarrow{\varphi} V_i(wy), \quad (16)$$

$$a_{p0}(we) \xrightarrow{\varphi} a_{pi}(wy), \quad (17)$$

$$f_{n0}(we) \xrightarrow{\varphi} f_{ni}(wy). \quad (18)$$

4.2. Global conditions of similarity

Analysis of technology enables to determine the similarity equations. The equations resulting from the power of cutting, cutting forces and volumetric efficiency of production.

After transformation was achieved system of equations:

$$\varphi_v \varphi_{F_c} = 1, \quad (19)$$

$$\varphi_{a_{pi}} \varphi_{f_{ni}} = 1, \quad (20)$$

$$\varphi_D * \varphi_{a_p} * \varphi_{f_n} * \varphi_n = 1. \quad (21)$$

When considering equation 19, 20, 21 finally we achieved a global technological conditions of similarity.

From the equation 19 on the account $\varphi_{F_c} = 1$, we can write that the similarity of the cutting speed remains constant for all elements of series of types.

$$\varphi_v = 1. \quad (22)$$

From equation 20 we get,

$$\varphi_{a_p} = \frac{1}{\varphi_{f_n}} \quad (23)$$

Substituting 23 to equation 21 we can write,

$$\varphi_D * \frac{1}{\varphi_{f_n}} * \varphi_{f_n} * \varphi_n = 1. \quad (24)$$

Finally, we have,

$$\varphi_v = \varphi_D * \varphi_n \quad (25)$$

From the equation 25 and the relation 22 we can write,

$$\varphi_n = \frac{1}{\varphi_D} \quad (26)$$

In result we can write,

$$\frac{1}{\varphi_n} * \frac{1}{\varphi_{f_n}} * \varphi_{f_n} * \varphi_n = 1, \quad (27)$$

Finally, the equation simplifies to the form 27 which confirms the correctness of the assumptions.

Based on the above transformations, we can conclude that it is not possible to preserve overall similarity. This follows from the fact that two numbers of similarity were obtained. Finally, technological similarity conditions can be written in the form:

$$\mathbf{W1-} \text{ depth of cut } \varphi_{a_p} = \varphi_{a_p}^i \quad (28)$$

$$\mathbf{W2-} \text{ feeds } \varphi_{f_n} = \frac{1}{\varphi_{a_p}^i} \quad (29)$$

$$\mathbf{W3 -} \text{ cutting speed } \varphi_v = 1 \quad (30)$$

$$\mathbf{W4 -} \text{ spindle speed } \varphi_n = \frac{1}{\varphi_{D_c}} \quad (31)$$

Technological features change according to conditions:

$$\text{depth of cut } a_{p_i} = a_{p0} * \varphi_{a_p}^i \quad (32)$$

$$\text{feeds } f_{n_i} = f_{n0} * \left(\frac{1}{\varphi_{a_p}} \right)^i \quad (33)$$

$$\text{cutting speed } v_i = v_0 * \varphi_{a_p}^0 \quad (34)$$

$$\text{spindle speed } n_i = n_0 * \left(\frac{1}{\varphi_{D_c}} \right)^i \quad (35)$$

If all of the technological parameters are dependent from one of number of similarities, there is complete similarity. In case of turning it is necessary to use two numbers of similarity therefore we have half-similarity. The practical verification of this method is presented in the next section.

4.3. Example of selection of machining parameters for turning

The paper was considered the selection of machining parameters for turning external, internal, face and grooving. The above-derived conditions are applicable to each of the varieties of rolling. Slight correction of the terms appears only in the case of grooving and face turning.

As an example of technology similarity verification are the elements of hydraulic actuators. The series of types with complete and no complete technology similarity were considered. Construction similarity number for diameter D series of types is $\varphi_D=1.06$, which corresponds to R20 preferred numbers. Amount range is determined by number i which, for technology model, is equal to zero. Adopted values range $i=(-10,6)$.

The following data was defined to determine the technology parameters:

- construction parameters model $\rightarrow D_0 = 20$ to 100 mm,
- material C15 with hardness 125 to 150 HB, $k_{c 0,4} = 1900$ N/mm²,
- Standard cut parameters $\rightarrow a_{p0} = 5$ mm, $f_{n0} = 0.6$ [mm/obr], $v_0 = 150$ [m/min].

External turning operations

The working range of changing rollers dimension was considered according to the structural similarity of the number 1.06. The cutting conditions including the elaborated similarities were generated. Each case for v parameters (Fig. 6), a_p (Fig. 7) can be calculated according to the specified algorithm and adapted to a particular machine tool (Tab. 1). These are the maximum values for a given assignment, which cannot be exceeded.

The parameter values are tested according to the deformations of elements. The criterion for limiting is length of element depending on the type of attachment (Tab. 2).

These criteria are the reason for derogation from the full technological similarities, as a result the corrected values of technological parameters and values describing the technological conditions such as the power of cutting (Fig. 8), cutting forces (Fig. 9) and cutting efficiency (Fig. 10) were obtained. So the adjusted variable is called the adjusted values.

These adjustments, however, are insignificant. The maximum value of derogations for a hole series ranges from 15%, as shown in Figures 8, 9, 10.

As a result of the analysis a number of processing parameters, which are input to the simulation of turning were obtained.

These results may be retrieved from the table and put into a specific process.

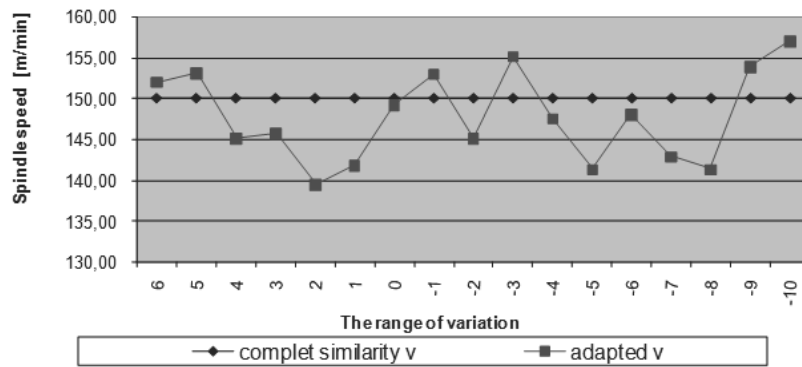

Fig. 6. The distribution of v parameter values, ideal and after adapted

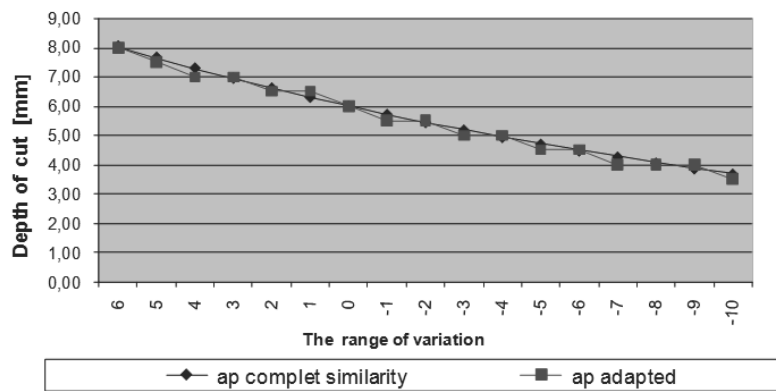

Fig. 7. The distribution of a_p parameter values, ideal and after adapted

Table 1.

Cutting power values after adapted parameters

Complete similarity			After adapted		
Force of cut F [N]	Cutting efficiency Q [mm ³ /min]	Power of cut P [kW]	Force of cut F [N]	Cutting efficiency Q [mm ³ /min]	Power of cut P [kW]
-10	3240	540.00	3150	510	7.9
-9	3240	540.00	3420	561	8.6
-8	3240	540.00	3240	529	8.1
-7	3240	540.00	3060	488	7.7
-6	3240	540.00	3240	550	8.1
-5	3240	540.00	3037.5	509	7.6
-4	3240	540.00	3037.5	496	7.6
-3	3240	540.00	3150	511	7.9
-2	3240	540.00	2925	477	7.3
-1	3240	540.00	3217.5	530	8.0
0	3240	540.00	2970	495	7.4
1	3240	540.00	3217.5	541	8.0
2	3240	540.00	3217.5	535	8.0
3	3240	540.00	3150	525	7.9
4	3240	540.00	3150	522	7.9
5	3240	540.00	3037.5	503	7.6
6	3240	540.00	3240	537	8.1

Proces of transformation

Table 2.
The values of deformation in dependence on seizing

Complete similarity				Lathe chuck	Lathe chuck- Running centre	Rnning centre - Running centre
	Force of cut F [N]	Cutting efficiency Q [mm ³ /min]	Diameter of cut (from , to>			
-10	3150	7.9	12	0.179700	0.192625463	0.175488402
-9	3420	8.6	14	0.102744	0.110134234	0.100336063
-8	3240	8.1	16	0.058744	0.062969606	0.05736747
-7	3060	7.7	18	0.033587	0.036003076	0.032800037
-6	3240	8.1	22	0.019204	0.020584876	0.018753528
-5	3037.5	7.6	25	0.010980	0.01176947	0.01072239
-4	3037.5	7.6	28	0.006278	0.006729232	0.006130561
-3	3150	7.9	32	0.003589	0.00384746	0.003505168
-2	2925	7.3	37	0.002052	0.002199798	0.002004091
-1	3217.5	8.0	43	0.001173	0.001257742	0.001145846
0	2970	7.4	50	0.000671	0.000719118	0.000655141
1	3217.5	8.0	58	0.000384	0.000411158	0.000374579
2	3217.5	8.0	66	0.000219	0.000235081	0.000214167
3	3150	7.9	76	0.000125	0.000134408	0.000122451
4	3150	7.9	87	0.000072	7.68484E-05	7.00115E-05
5	3037.5	7.6	100	0.000041	4.39383E-05	4.00293E-05
6	3240	8.1	115	0.000023	2.51219E-05	2.28869E-05
The maximum length of element for the minimum pitch diameter [mm]				100	340	250

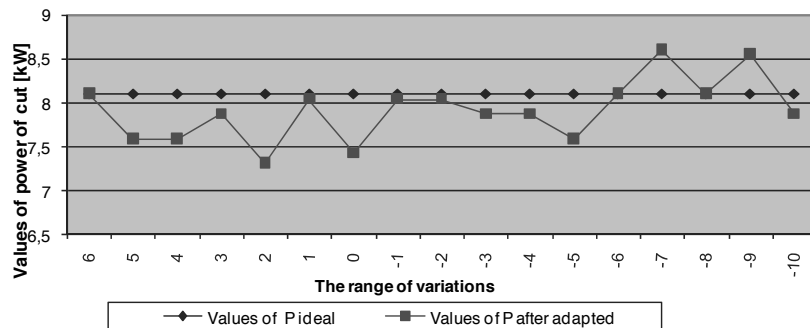

Fig. 8. The distribution of cutting power values (ideal and after adapted)

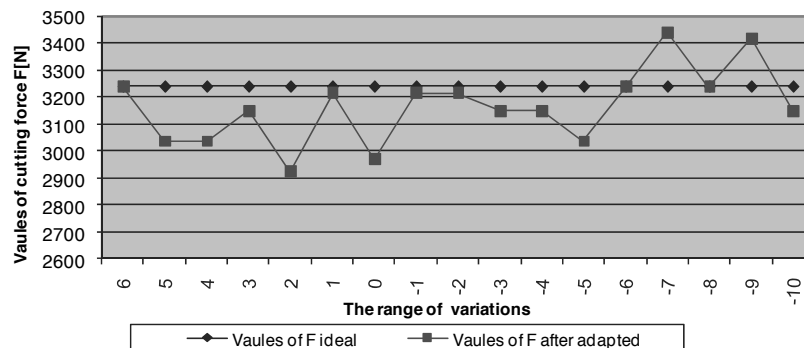

Fig. 9. The distribution of cutting force values, (ideal and after adapted)

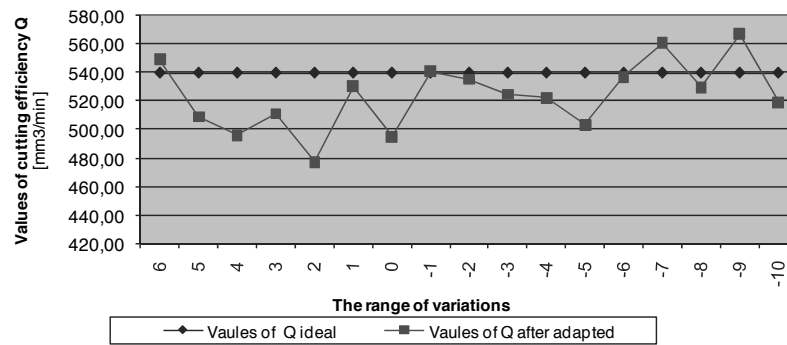

Fig. 10. The distribution of cutting efficiency values (ideal and after adapted)

The basic methodological assumption to create series of types of element in turning operations (the hydraulic servo-motors) is constant or the imperceptibly differential structure of technology Γ^{te_j} and the variation of technological parameters $T_a^{te_j}$ (Equation 36).

$$te_n^{te_j} = (\Gamma^{te_j})_{const} \cup (T_a^{te_j})_{var} \quad (36)$$

In order to obtain the most effective integration of process creating series of technology including a process creating the ordered construction performance under-mentioned standards, the following must be required:

- 1) sorting constructional data (constructional features) making up the basis to create technological components of the ordered technology,
- 2) transferring from construction the greatest number of data to the process of production,
- 3) maximum connection of constructional features with manufacturing technology,
- 4) minimisation of information redundancy,
- 5) development of the relational database,
- 6) minimization of variety of construction and technological processes particularly along with constructors and technologists' subjective feelings [14],
- 7) developing computer programmes and their application in order to integrate the working environment process engineers and design engineers [13,15],
- 8) typical constructional solutions and technological processes, which modules computational programmes should be presented.

The process of technology ordering is realized for series or module series applying them in identical possible operations, cuts, parameters of processing, seizing, tools, gears [10].

References

- [1] G. Pahl, W. Beitz, Science of construction, WNT, Warsaw, 1984 (in Polish).
- [2] P. Gendarz, M. Cielniak, Computer aided generation of construction model for construction similarity theory, Journal of Achievements in Materials and Manufacturing Engineering 44/1 (2011) 80-87.
- [3] A. Buchacz, Modelling of robots by means the hypergraphs method, Proceedings of the 9th International Scientific Conference "Achievements in Mechanical and Materials Engineering" AMME'2000, Gliwice-Sopot- Gdańsk, 2000, 63-66.
- [4] C. Grabowik, Selected aspects of methodology of a CAPP system design, Journal of Machine Engineering, Model Based Manufacturing Operation 11/1-2 (2011) 78-88.
- [5] Z. Adamczyk, K. Kociolek, CAD/CAM technological environment creation as an interactive application on the Web, Journal of Materials Processing Technology 109/3 (2001) 222-228.
- [6] F. Gabryelewicz, Typification of production in engineering industry, WNT, Warsaw, 1976 (in Polish).
- [7] C. Grabowik, K. Kalinowski, Object-oriented models in an integration of CAD/CAPP/CAP systems, Hybrid Artificial Intelligent Systems, Lectures Notes in Artificial Intelligence 6678 (2011) 405-412.
- [8] J. Świder, K. Herbuś, P. Ociepka, The application of object methods for functional features representation, Proceedings of the 13th International Scientific Conference "Achievements in Mechanical and Materials Engineering" AMME'2005, Gliwice- Wisła, 2005, 655-658.
- [9] Z. Siuzdak, J. Wisniewski, Group processing, Warsaw, 1964 (in Polish).
- [10] R. Rzański, P. Gendarz, Methods of creation series of types of technology, Journal of Achievements in Materials and Manufacturing Engineering 36/2 (2009) 150-159.
- [11] R. Rzasinski, P. Gendarz, The creation of ordered technologies on the basic of ordered constructions of machines, Proceedings of the 3rd Scientific Conference "Materials, Mechanical and Manufacturing Engineering" MMME'2005, Gliwice- Wisła, 2005, 203-207.
- [12] R. Rzański, Databases and computer programs selection of technological features, Journal of Achievements in Materials and Manufacturing Engineering 49/2 (2011) 350-359.
- [13] F. Čus, B. Mursec, Databases for technological information systems, Journal of Materials Processing Technology 157-158 (2004) 75-81.
- [14] L.I. Siedow, Dimensional analysis and theory of similarity in mechanics, WNT, Warsaw 1968, (in Polish).
- [15] S.Tkaczyk, M. Skucha, The application of the Balanced Scorecard Method in Organization Management, Proceedings of the 9th International Scientific Conference "Achievements in Mechanical and Materials Engineering" AMME'2000, Gliwice-Sopot-Gdańsk, 2000, 549-552.