

Indication of the suitable model of a mechatronic system as an introduction to the synthesis task

M. Placzek*

Institute of Engineering Processes Automation and Integrated Manufacturing Systems, Faculty of Mechanical Engineering, Silesian University of Technology, ul. Konarskiego 18a, 44-100 Gliwice, Poland

* Corresponding author: E-mail address: marek.placzek@polsl.pl

Received 13.10.2011; published in revised form 01.12.2011

Analysis and modelling

ABSTRACT

Purpose: The identification of the optimal mathematical model that meets the assumed criteria is the main purpose of this paper, which is an introduction to the task of synthesis of one-dimensional vibrating mechatronic systems. Assumed criteria are to provide the accurate analysis of the system together with maximum simplification of used mathematical tools and minimize required amount of time. The correct description of a given system by its model during the design phase is a fundamental condition for proper operation of it. Therefore, the processes of modelling, testing and verification of used models were presented. On the basis of carry out analysis the optimal (in case of assumed criteria) model was selected and it will be used to realize the task of synthesis in future works.

Design/methodology/approach: A series of mathematical models with different simplifying assumptions was created. Using the created models and corrected approximate Galerkin method the dynamic characteristic of the considered system was designated. The analysis of an influence of parameters of the system's components on obtained characteristic was conducted. The approximate method was verified to check its accuracy and decide if it can be used to analyse such kind of mechatronic systems.

Findings: The main result of the work is an indication of the suitable mathematical model of the considered system.

Research limitations/implications: Influence of temperature changes on the transducer's properties was neglected in developed mathematical models. It will be considered in the future works.

Practical implications: Presented method of mechatronic system's analysis can be used in process of designing of technical devices where both, simply and reverse piezoelectric effects can be used.

Originality/value: Development of the mathematical models in which the considered system is modelled as a combined beam.

Keywords: Applied mechanics; Vibrating mechatronic systems; Approximate methods; Piezoelectric transducers

Reference to this paper should be given in the following way:

M. Placzek, Indication of the suitable model of a mechatronic system as an introduction to the synthesis task, Journal of Achievements in Materials and Manufacturing Engineering 49/2 (2011) 338-349.

1. Introduction

The paper presents the issues of modelling and testing of flexural vibrating mechatronic systems with piezoelectric transducers used as vibration dampers. The method of analysis of the considered system is presented, started from development of the mathematical model, by setting its characteristics, to determine the influence of the system's properties on these characteristics.

Considered system is an example of piezoelectric effect application in technical devices. Piezoelectricity has found a lot of applications since it was discovered in 1880 by Pierre and Jacques Curie. There are many applications of the direct piezoelectric effect – the production of an electric potential when stress is applied to the piezoelectric material, as well as the reverse piezoelectric effect – the production of strain when an electric field is applied [1]. The discussed subject is important due to increasing number of applications, both simple and reverse piezoelectric phenomena in various modern technical devices. The process of modelling of technical devices with piezoelectric materials is complex and requires large amounts of time because of the complexity of the phenomena occurring in these systems.

The correct description of a given system by its mathematical model during the design phase is a fundamental condition for proper operation of the designed system. Therefore, in the paper the processes of modelling, testing and verification of used mathematical models of one-dimensional vibrating mechatronic system is presented. A series of discrete-continuous and continuous-continuous mathematical models with different simplifying assumptions was created. Using the created models and corrected approximate Galerkin method the characteristic of the considered system was designated. The analysis of an influence of geometrical and material parameters of system's components on obtained characteristic was conducted, including a glue layer between the piezoelectric transducer and a mechanical subsystem. To generalize, the obtained results were presented in a dimensionless form. A mathematical model that provides the most accurate analysis of the system together with maximum simplification of used mathematical tools and minimize required amount of time was indicated.

In this paper analysis of mechatronic system with direct piezoelectric effect application in mechatronic system is presented. In considered system piezoelectric transducers is used as vibration damper with the external shunting electric circuit. Presented method can be also used in relation to analysis of mechatronic systems with piezoelectric actuators – the reverse piezoelectric effect applications. In this case piezoelectric transducers can be used as actuators glued on the surface of a mechanical subsystem in order to generate desired vibrations or also to control and damp vibrations in active damping applications [2, 3]. In this case electric voltage is generated by external control system and applied to the transducer. In the presented case piezoelectric transducers are used as passive vibration dampers. A passive electric network is adjoined to transducer's clamps. The possibility of dissipating mechanical energy with piezoelectric transducers shunted with passive electric circuits was experimentally investigated and described in many publications [4-7]. There are two basic applications of this idea. In the first method, only a resistor is used as a shunting circuit and in the second method it is a passive electric circuit

composed of a resistor and inductor. Many authors have worked to improve this idea. For example multimode piezoelectric shunt damping systems were described [8]. What is more there are many commercial applications of this idea [9].

Mechatronic systems with piezoelectric sensors or actuators are widely used because piezoelectric transducers can be applied in order to obtain required dynamic characteristic of designed system. It is very important to use very precise mathematical model and method of the analysis of the system to design it correctly. It was proved that it is very important to take into consideration influence of all elements of analysed system including a glue layer between piezoelectric transducer and mechanical subsystem [10, 11]. It is indispensable to take into account geometrical and material parameters of all system's components because the omission of the influence of one of them results in inaccuracy in the analysis of the system.

Indication of a suitable mathematical model of considered system is the first and very important step, which should be done as an introduction to the task of synthesis of such kind of mechatronic systems. So, the identification of the optimal mathematical model that meets the assumed criteria is the main purpose of this work. Tasks of analysis and synthesis of mechanical and mechatronic systems were considered in Gliwice centre in previous works [12-15]. Passive and active mechanical systems and mechatronic systems with piezoelectric transducers were analysed [16, 17]. Works were also supported by computer-aided methods [18, 19].

2. Description of considered system, work methodology and assumptions

In this paper the one-dimensional, flexural vibrating mechatronic system with passive, piezoelectric vibration damper is considered. It was created by applying a piezoelectric transducer to the surface of a mechanical subsystem. An external, passive electric circuit is adjoined to the transducer's clamps. In the considered system it is a resistor with resistance R_Z . Vibration of the mechanical subsystem causes, that the piezoelectric transducer generates electric voltage in agreement with the direct piezoelectric effect. Generated electric charge is dissipated on the externally applied resistor and change into a heat. It introduces additional stiffness of electromechanical nature [7].

In order to analyse the considered system, the approximate Galerkin method was used. First, a series of mathematical models of the system was developed. Finally, the dynamic flexibility of the system was calculated and influence of the system's components prosperities on it was verified.

2.1. Mechatronic system with piezoelectric passive vibration damper

The considered mechatronic system with passive piezoelectric vibration damper is presented in Fig. 1. It is a mechanical subsystem - cantilever beam which has a rectangular constant

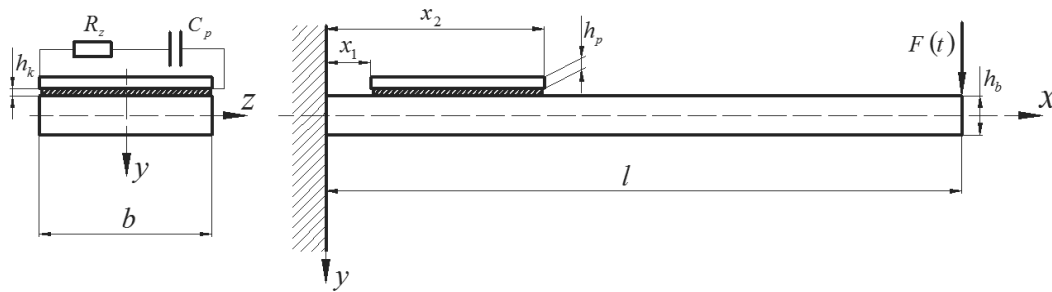

Fig. 1. Shape of the considered system with piezoelectric passive vibration damper

cross-section, length l , width b and thickness h_b . Young's modulus of the beam is denoted E_b . A piezoelectric transducer of length l_p is bonded to the mechanical subsystem's surface within the distance of x_1 from a clamped end of the beam. The transducer is bonded by a glue layer of thickness h_k and Kirchhoff's modulus G . The glue layer has homogeneous properties in overall length.

The analysed system is excited by externally applied harmonic force, described by the equation:

$$F(t) = F_0 \cos(\omega t). \quad (1)$$

Searching dynamic characteristic of the considered system – the dynamic flexibility α_Y is defined in agreement with the equation:

$$y(x, t) = \alpha_Y \cdot F(t), \quad (2)$$

where $y(x, t)$ is the linear displacement of the beam's sections in the direction perpendicular to the beam's axis. In order to make analysis of obtained results easier, the absolute value Y of the dynamic flexibility will be designated and presented in graphical form.

It was assumed that the beam is made of steel and piezoelectric transducer is a PZT transducer – Pz29 [20]. Geometric and material parameters of the system's elements are presented in Table 1.

Table 1.

The system's parameters

Geometric parameters	Material parameters
$l = 0.24 [m]$	$E_b = 210000 [MPa]$
$b = 0.04 [m]$	$\rho_b = 7850 \left[\frac{kg}{m^3} \right]$
$h_b = 0.002 [m]$	$\eta_b = 8 \cdot 10^{-5} [s]$
$x_1 = 0.01 [m]$	$d_{31} = -240 \cdot 10^{-12} \left[\frac{m}{V} \right]$
$x_2 = 0.09 [m]$	$e_{33}^T = 2900 \cdot \epsilon_0 \left[\frac{F}{m} \right]$
$h_p = 0.001 [m]$	$s_{11}^E = \frac{1}{c_{11}^E} = 17 \cdot 10^{-12} \left[\frac{m^2}{N} \right]$
$b_p = 0.04 [m]$	$\rho_p = 7450 \left[\frac{kg}{m^3} \right]$
$h_k = 0.0001 [m]$	$G = 1000 \cdot 10^6 [Pa]$

Symbols ρ_b and ρ_p denote density of the beam and transducer. d_{31} is a piezoelectric constant, e_{33}^T is a permittivity at zero or constant stress, s_{11}^E is flexibility and c_{11}^E is a Young's modulus at zero or constant electric field.

2.2. Assumptions

In order to analyse vibration of the systems following assumptions were made:

- material of which the system is made is subjected to Hooke's law,
- the system has a continuous, linear mass distribution,
- the system's vibration is harmonic,
- planes of sections that are perpendicular to the axis of the beam remain flat during deformation of the beam – an analysis is based on the Bernoulli's hypothesis of flat sections,
- displacements are small compared with the dimensions of the system.

In the considered system internal resistance of the transducer (usually 50-100 Ω [21]) is negligibly small in relation to the resistance of externally applied electric circuit (400 k Ω), so it was omitted. Taking into account an equivalent circuit of the piezoelectric transducer presented in Fig. 2, an electromotive force generated by the transducer and its electrical capacity are treated as a serial circuit. The piezoelectric transducer with an external shunt resistor is treated as a serial RC circuit with a harmonic voltage source generated by the transducer [1, 21, 22].

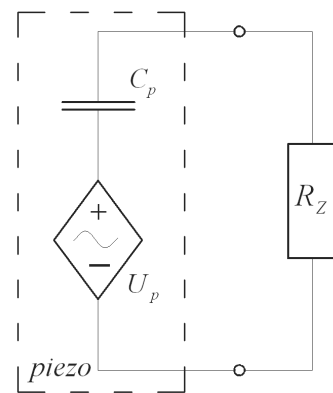

Fig. 2. The substitute scheme of the piezoelectric transducer with an external shunt circuit [1, 21, 22]

Piezoelectric materials can be described by a pair of constitutive equations which includes the relationship between mechanical and electrical properties of transducers [1, 5]. In case of the considered system these equations can be written as:

$$D_3 = \varepsilon_{33}^T E_3 + d_{31} T_1, \quad (3)$$

$$S_1 = d_{31} E_3 + s_{11}^E T_1. \quad (4)$$

where: ε_{33}^T , d_{31} , s_{11}^E are dielectric, piezoelectric and elasticity constants. By superscripts T and E value under zero/constant strain or zero/constant electric field. In this case the piezoelectric constant d_{31} was introduced in constitutive equations. It denotes, that it is a relation between the transducer's strain in the direction of the axis 1 and electric field in the direction of the axis 3 [1, 5]. Symbols D_3 , S_1 , T_1 and E_3 denote electrical displacement, strain, stress and electric field intensity in the direction of axes denote by the subscripts. In Fig. 3 assumed denotation of axes is presented.

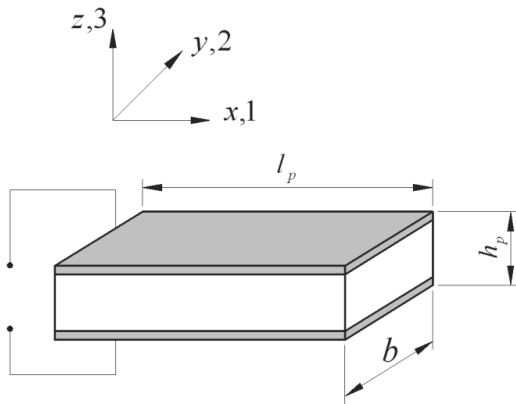

Fig. 3. Scheme of a piezoelectric transducer with denotation of axes of coordinate system

Structural damping of the beam and glue layer was taken into account in mathematical models of considered systems using Kelvin-Voigt model of material. It was introduced by replacing Young's modulus of the beam and modulus of elasticity in shear of the glue layer by equations:

$$E_b^* = E_b \left(1 + \eta_b \frac{\partial}{\partial t} \right), \quad (5)$$

$$G^* = G \left(1 + \eta_k \frac{\partial}{\partial t} \right), \quad (6)$$

where: η_b and η_k denote structural damping coefficients of the mechanical subsystem and the glue layer [10].

2.3. Approximate Galerkin method

It is impossible to use exact Fourier method of separation of variables in analysis of mechatronic systems. This is why the approximate Galerkin method was used to analyse considered

system. Verification of this method was the first step. In order to check accuracy of the approximate method the mechanical subsystem was analysed twice, using the exact Fourier and approximate Galerkin methods. The dynamic flexibility of the mechanical subsystem was designated and obtained results were juxtaposed (see Fig. 4).

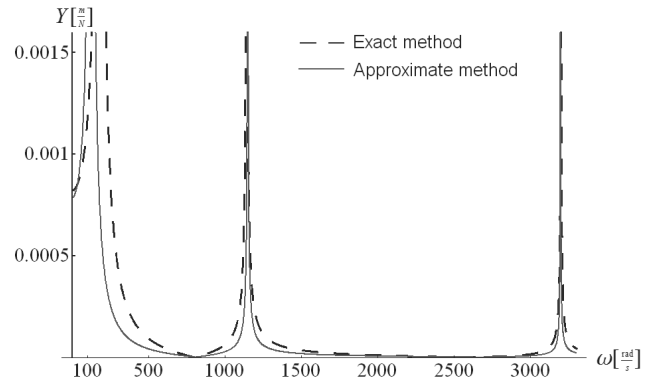

Fig. 4. The dynamic flexibility of the mechanical subsystem: exact and approximate methods, for $n=1,2,3$

In the approximate method solution of differential equation was assumed as a simple equation [4, 11]:

$$y(x,t) = A \sum_{n=1}^{\infty} \sin k_n x \cos \omega t, \quad (7)$$

where A is an amplitude of vibration. It fulfils only two boundary conditions – deflection of the clamped and free ends of the beam.

As it is shown in Fig. 4, inexactness of the approximate method is very meaningful for the first three natural frequencies. Shifts of values of the system's natural frequencies are results of the discrepancy between the assumed solution of the system's differential equation of motion in the approximate method (equation 7) and solution obtained on the basis of graphic solution of the system's characteristic equation in the well known exact method.

The approximate method was corrected for the first three natural frequencies of the considered system by introduction correction coefficients described by the equation:

$$\Delta \omega_n = \omega_n - \omega_n', \quad (8)$$

where ω_n and ω_n' are values obtained using the exact and approximate methods, respectively. Results obtained after corrections of the approximate Galerkin method are presented in Fig. 5.

The corrected approximate Galerkin method gives a very high accuracy and obtained results can be treated as very precise. It can be used to analyse mechatronic systems with piezoelectric transducers. The considered mechanical subsystem was chosen purposely because inexactness of the approximate Galerkin method is the biggest in this way of fixing.

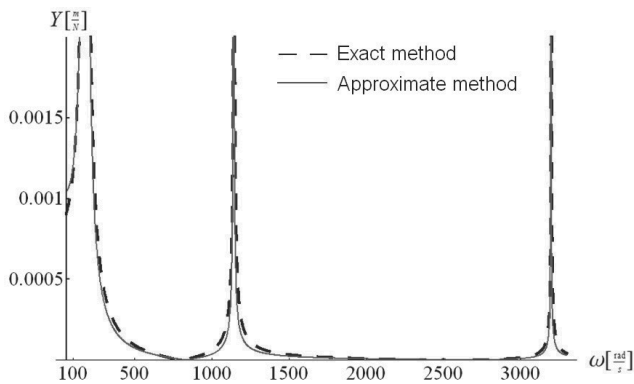

Fig. 5. The dynamic flexibility of the mechanical subsystem – exact and corrected approximate methods, for $n=1,2,3$

3. A series of mathematical models

A series of mathematical models of the considered mechatronic system with different simplifying assumptions was created. Discrete-continuous and continuous models were developed. In the first case of discrete-continuous models, the mechanical subsystem was described taking into account a continuous mass distribution of the system. The piezoelectric transducer with externally applied passive electric network was described by the discrete model, taking into account well known equations from the analysis of electric circuits. In the second case, both mechanical subsystem and piezoelectric transducer were described taking into account a continuous mass distribution. In all mathematical models the differential equation of the mechanical subsystem's motion was assigned in agreement with the d'Alembert's principle. In all mathematical models impact of the piezoelectric transducer was limited by introducing Heaviside function, due to the fact that it is attached to the surface of the mechanical subsystem on the section from x_1 to x_2 . It was denoted by symbol H and described by the equation:

$$H = H(x - x_1) - H(x - x_2). \quad (9)$$

The dynamic flexibility of the considered mechatronic system was calculated using the corrected approximate Galerkin method.

3.1. Discrete-continuous model with an assumption of perfectly bonded piezoelectric transducer

In the first mathematical model (model 1) the glue layer between the piezoelectric transducer and surface of the mechanical subsystem was neglected. It was assumed that the transducer's strain and strain of the mechanical subsystem's surface are exactly the same. After transformation of constitutive equations (3 and 4), the bending moment generated by the transducer can be described as:

$$M_p(x, t) = \frac{h_b + h_p}{2} c_{11}^E A_p [S_1(x, t) - \lambda_1(t)], \quad (10)$$

where:

$$\lambda_1(t) = d_{31} \frac{U_C(t)}{h_p}. \quad (11)$$

Symbol c_{11}^E denotes Young's modulus of the transducer at zero/constant electric field (inverse of elasticity constant). $U_C(t)$ is an electric voltage on the capacitance C_p of the piezoelectric transducer.

Arrangement of forces and bending moments acting in the system were being taken into consideration in order to write down the differential equation of motion:

$$\frac{\partial^2 y(x, t)}{\partial t^2} = -a^4 \left(1 + \eta_b \frac{\partial}{\partial t} \right) \frac{\partial^4 y(x, t)}{\partial x^4} + \frac{(h_b + h_p) \cdot c_{11}^E A_p}{2 \rho_b A_b} \cdot \frac{\partial^2}{\partial x^2} [H \cdot S_1(x, t) - H \cdot \lambda_1(t)] + \frac{\delta(x-l)}{\rho_b A_b} \cdot F(t), \quad (12)$$

where:

$$a = \sqrt[4]{\frac{E_b J_b}{\rho_b A_b}}. \quad (13)$$

Distribution of the external force was determined using Dirac delta function $\delta(x-l)$.

Equation of the piezoelectric transducer with external electric circuit can be described as:

$$R_Z C_p \frac{\partial U_C(t)}{\partial t} + U_C(t) = U_p(t), \quad (14)$$

Symbol $U_p(t)$ denotes electric voltage generated by the transducer as a result of its strain that can be calculated as a quotient of generated electric charge and capacitance of the transducer. Equation of electric charge generated by the transducer was obtained using constitutive equations and finally, equation of the piezoelectric transducer with external electric circuit can be described as:

$$R_Z C_p \frac{\partial U_C(t)}{\partial t} + U_C(t) = \frac{l_p b d_{31} S_1(x, t)}{C_p s_{11}^E} + \frac{l_p b \varepsilon_{33}^T U_C(t)}{C_p h_p} (1 - k_{31}^2), \quad (15)$$

where:

$$S_1(x, t) = \frac{h_b}{2} \cdot \frac{\partial^2 y(x, t)}{\partial x^2}, \quad (16)$$

$$k_{31}^2 = \frac{d_{31}^2}{s_{11}^E \varepsilon_{33}^T}, \quad (17)$$

are the transducer's strain and electromechanical coupling constant that determines the efficiency of conversion of mechanical energy into electrical energy and electrical energy into mechanical energy of the transducer [23].

System of equations obtained using equations (12) and (15) is the discrete-continuous mathematical model of the system under consideration with an assumption of perfectly bonded piezoelectric vibration damper.

3.2. Discrete-continuous model with an assumption of pure shear of the glue layer

In the second mathematical model (model 2) the impact of the glue layer between the transducer and the mechanical subsystem's surface was concerning. The mathematical model of the system under consideration was developed in order to obtain more detailed representation of the real system. A pure shear of the glue layer was assumed. Shear stress was determined according to the Hook's law, assuming small values of pure non-dilatational strain. Uniform distribution of shear stress along the glue layer was assumed. The transducer's strain was assumed as a difference of the glue layer's upper surface strain and the free transducer's strain that is a result of electric field on its electrodes. Finally, mathematical model of the considered mechatronic system was obtained:

$$\left\{ \begin{aligned} \frac{\partial^2 y(x,t)}{\partial t^2} &= -a^4 \left(1 + \eta_b \frac{\partial}{\partial t} \right) \frac{\partial^4 y(x,t)}{\partial x^4} + \\ &+ \frac{Gl_p}{2\rho_b h_k} \left(1 + \eta_k \frac{\partial}{\partial t} \right) \frac{\partial}{\partial x} H[\varepsilon_b(x,t) - \varepsilon_k(x,t) + \lambda_1(t)] + \\ &+ \frac{\delta(x-l)}{\rho_b A_b} F(t) \\ R_Z C_p \frac{\partial U_C(t)}{\partial t} + U_C(t) &= \frac{l_p b d_{31}}{C_p s_{11}^T} S_1(x,t) + \frac{l_p b \varepsilon_{33}^T}{C_p h_p} (1 - k_{31}^2) \cdot U_C(t) \end{aligned} \right. \quad (18)$$

where: ε_b and ε_k are the beam and the glue layer's surfaces strains.

3.3. Discrete-continuous model taking into account a shear stress and eccentric tension of the glue layer

In the next mathematical model (model 3) the system under consideration was modelled as a combined beam in order to unify parameters of all components [24]. Shear stress and eccentric tension of the glue layer were assumed. The substitute cross-section of the system was introduced by multiplying the width of the piezoelectric transducer and the glue layer by factors:

$$m_p = \frac{c_{11}^E}{E_b}, \quad m_k = \frac{2G(1+\nu)}{E_b}. \quad (19)$$

Symbol ν denotes the Poisson's ratio of the glue layer.

Taking into account the eccentric tension of the glue layer under the action of forces acting in the system, the stress on the substitute cross-section's surfaces was assigned. Using the basic laws and dependences from theory of strength of materials the real strain of the piezoelectric transducer was assigned:

$$S_1(x,t) = T_1 \cdot \varepsilon_b(x,t) - T_2 \cdot \lambda_1(t), \quad (20)$$

where:

$$T_1 = \frac{h_p - y_w}{(h_p + h_k - y_w) \left[1 - \frac{E_p A_p}{E_b A_w} \left(\frac{h_p - y_w}{h_p + h_k - y_w} - 1 \right) \right]}, \quad (21)$$

$$T_2 = \frac{E_p \frac{A_p}{A_w} \left(\frac{h_p - y_w}{h_p + h_k - y_w} - 1 \right)}{E_b \left[1 - \frac{E_p A_p}{E_b A_w} \left(\frac{h_p - y_w}{h_p + h_k - y_w} - 1 \right) \right]}. \quad (22)$$

Symbols A_w and y_w are the area and location of the central axis of the substitute cross-section.

To determine the value of shear stress on the plane of contact of the transducer and beam the following dependence was used:

$$\tau(x,y) = \frac{T(x,t) \cdot S_z(y)}{J_w \cdot b(y)}, \quad (23)$$

where $S_z(y)$ is a static moment of cut off part of the composite beam's cross-section relative to the weighted neutral axis. Transverse force $T(x,t)$ can be calculated as a derivative of bending moment acting on the system's cross-section.

Finally, the discrete-continuous mathematical model of the considered system was developed as a system of equations, analogical as in the previous cases.

3.4. Discrete-continuous model taking into account a bending moment generated by the transducer and eccentric tension of the glue layer

Taking into account parameters of the combined beam introduced in the previous model, the discrete-continuous mathematical model with influence of the glue layer on the dynamic characteristic of the system was developed (model 4). However, in this model the impact of the piezoelectric transducer was described as a bending moment, similarly as in the mathematical model with the assumption of perfectly attachment of the transducer. Homogeneous, uniaxial tension of the transducer was assumed and its deformation was described by the equation (20). In this case the bending moment generated by the transducer can be described as:

$$M_p(x,t) = \left(\frac{h_p + h_b}{2} + h_k \right) c_{11}^E A_p [T_1 \varepsilon_b(x,t) - (T_2 + 1) \lambda_1(t)] \quad (24)$$

Discrete-continuous mathematical model of the system under consideration was created as a system of differential equation of the mechanical subsystem's motion and equation of the piezoelectric transducer with external electric circuit, treated as a linear RC circuit.

3.5. Continuous model with an assumption of uniaxial tension of the piezoelectric transducer

Next, a continuous mathematical model was created (model 5). Mechanical subsystem and piezoelectric transducer were described taking into account a continuous mass distribution. In this model the system under consideration was modelled as the combined beam. Uniaxial, homogeneous strain of the transducer was assumed and differential equation of motion of the piezoelectric transducer was obtained:

$$\frac{\partial^2 u(x,t)}{\partial t^2} = \frac{c_{11}^E}{\rho_p} \frac{\partial^2 u(x,t)}{\partial x^2} + \frac{b}{\rho_p A_p} \tau, \quad (25)$$

where ρ_p denotes density of the piezoelectric transducer, τ denotes shearing stress, generated in the glue layer and $u(x,t)$ is the transducer's elements displacement in the direction of its geometrical axis:

$$u(x,t) = \int [T_1 \varepsilon_b(x,t) - T_2 \lambda_1(t)] dx \quad (26)$$

Arrangement of shearing forces and bending moments acting in this case on the cut out part of system with length dx are presented in Fig. 6.

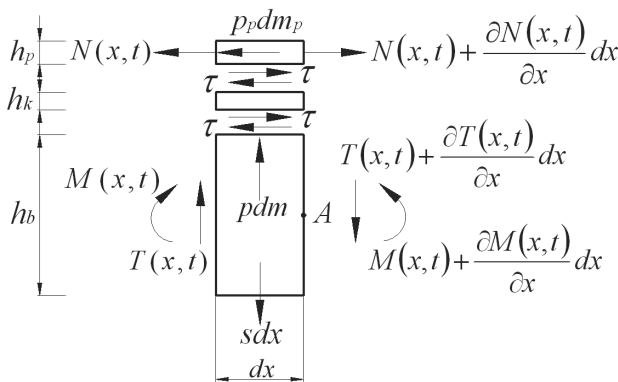

Fig. 6. Arrangement of shearing forces and bending moments acting on the cut-out part of system with length dx

In this case obtained mathematical model of the system under consideration was very complicated and process of the dynamic flexibility calculation requires a large amount of work [25].

3.6. Continuous model taking into account flexural vibration of the piezoelectric transducer

The last mathematical model (model 6) of the considered mechatronic system was also a continuous model. In this model flexural vibration of the piezoelectric transducer was being taken into consideration. Differential equations of the mechanical subsystem and piezoelectric transducer's flexural vibration were obtained on the basis of an arrangement of forces and bending moments acting on the cut-out part of system with length dx , presented in Fig. 7.

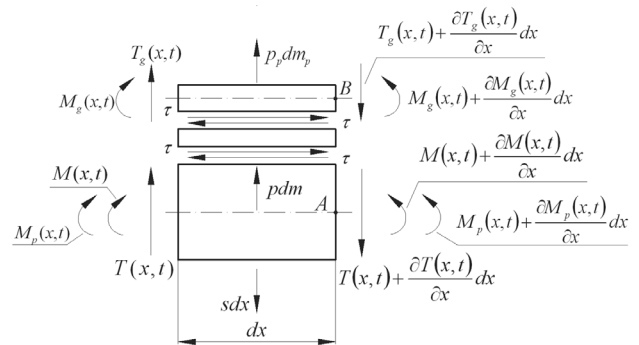

Fig. 7. Arrangement of forces and bending moments acting on the cut-out part of system with length dx

The considered system was modelled as the combined beam and a linear displacement $g(x,t)$ of the transducer's elements in the direction perpendicular to its geometrical axis was described as:

$$g(x,t) = \iint \left[-\frac{T_1}{r_p} \varepsilon_b(x,t) + \frac{T_2}{r_p} \lambda_1(t) \right] dx dx \quad (27)$$

Obtained equation of the transducer's flexural vibrations was:

$$\frac{\partial^2 g(x,t)}{\partial t^2} = -\frac{c_{11}^E J_p}{\rho_p A_p} \cdot \frac{\partial^4 g(x,t)}{\partial x^4} + \frac{1}{2 \rho_p} \frac{\partial \tau}{\partial x}, \quad (28)$$

where A_p and J_p are the transducer's cross-section area and moment of inertia.

4. Obtained results – the dynamic flexibility of the system under consideration

Developed mathematical models of the considered mechatronic system with piezoelectric vibration damper were used to calculate the dynamic flexibility of the system using the corrected approximate Galerkin method. Suitable derivatives of the assumed solution of the differential equation of motion (7)

were inserted in obtained mathematical models. After transformations, the system's dynamic flexibility was designated. Process of the mechatronic system's dynamic flexibility calculation was presented in details in other publications [4, 11, 24, 25].

Obtained results (absolute value of the considered mechatronic system's dynamic flexibility) are presented on charts in a half logarithmic scale in Fig. 8, for the first three natural frequencies.

Using developed mathematical models and corrected approximate Galerkin method very similar course of the dynamic flexibility were obtained. Shift of the natural frequencies in the direction of higher values of the mechatronic system in the direction of higher values can be observed. This shift is a result of increased stiffness of mechatronic system compared with the mechanical subsystem.

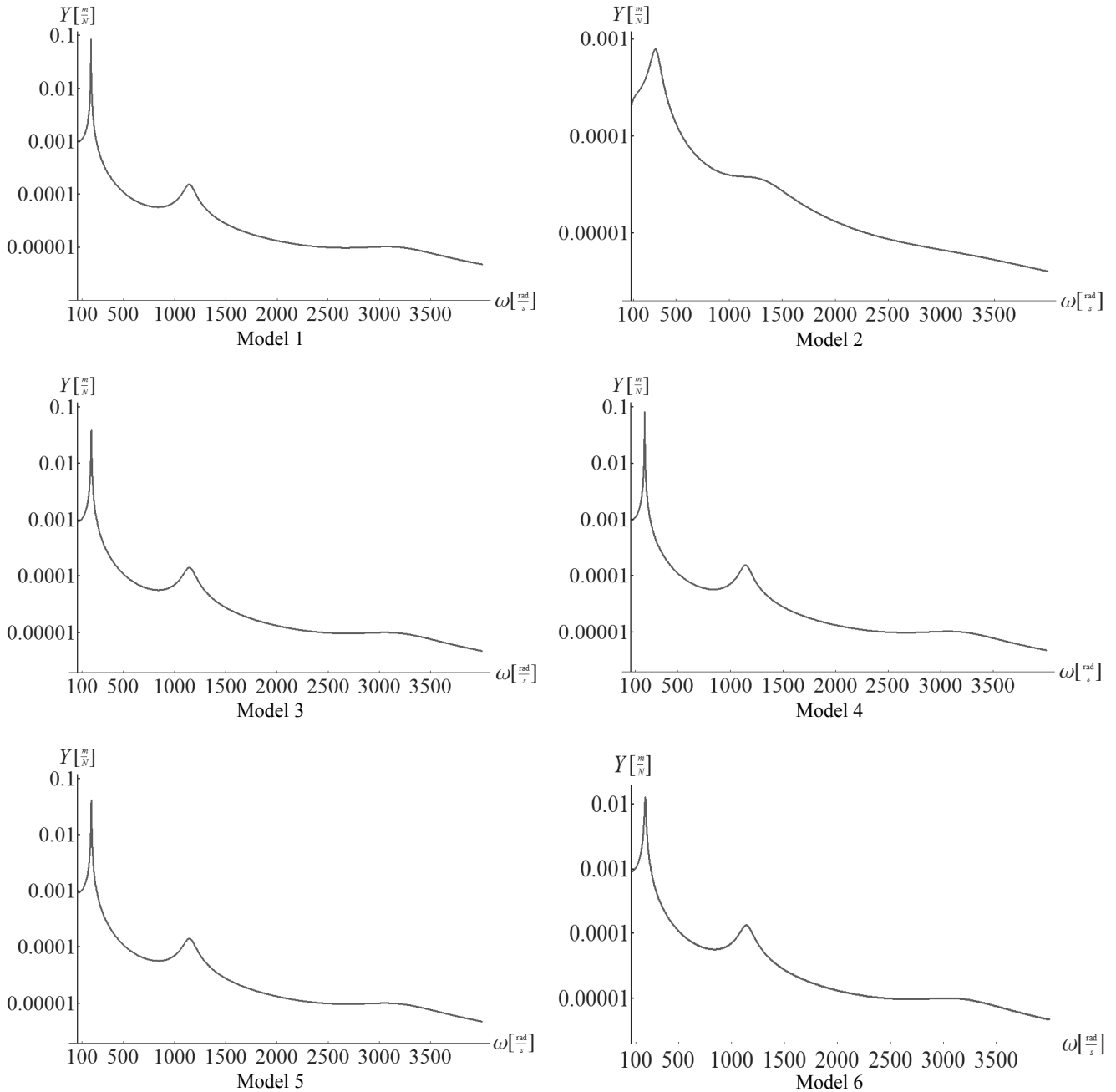

Fig. 8. Absolute value of the dynamic flexibility of mechatronic system with piezoelectric vibration damper, for the first three natural frequencies

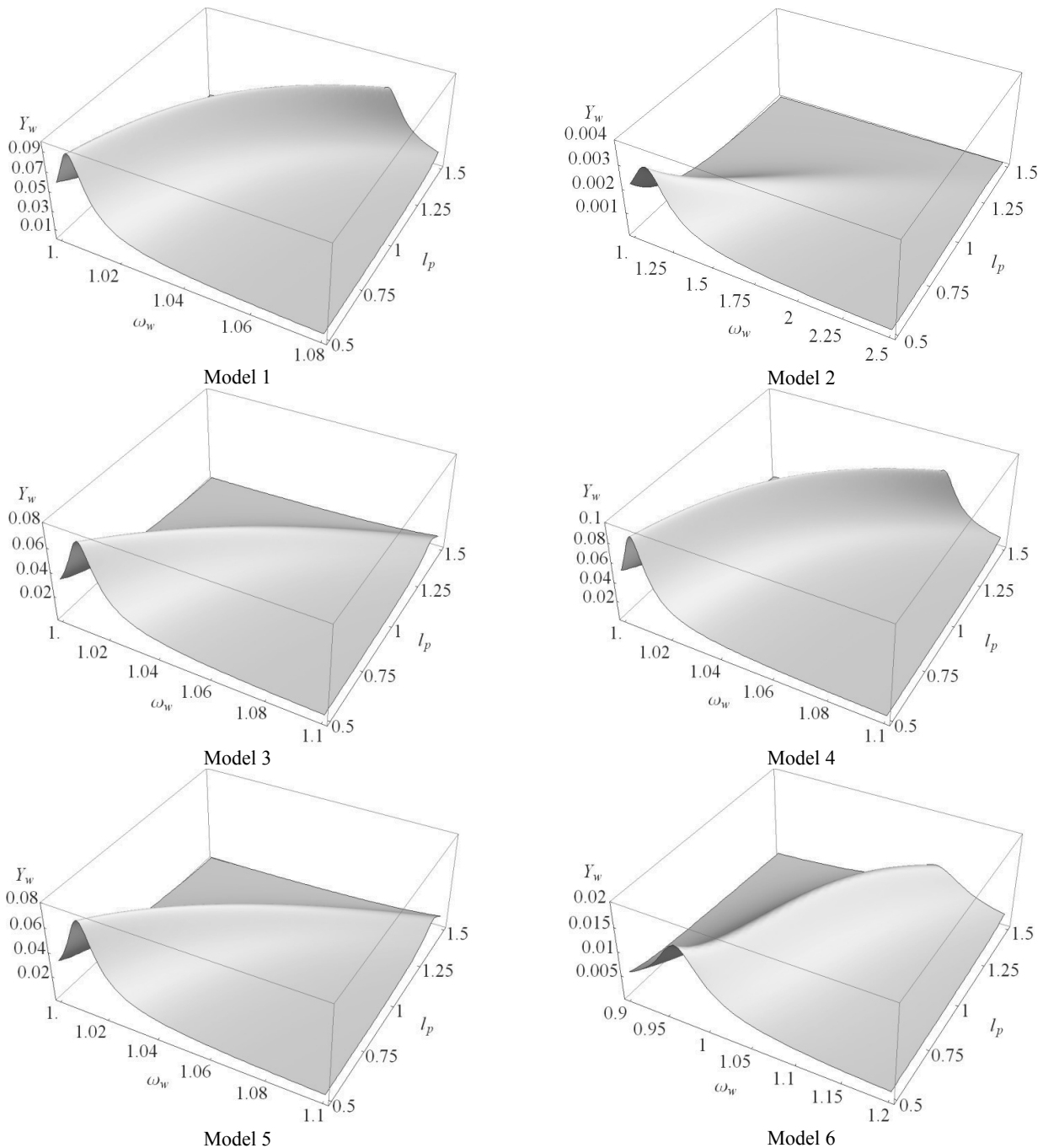

Fig. 9. Influence of the piezoelectric transducer's length on the absolute value of the dimensionless dynamic flexibility of the mechatronic system with piezoelectric vibration damper

Precision of the mathematical model of considered system has no big influence on the obtained results. There are no significant differences between the values of natural vibration frequencies of considered systems and course of dynamic characteristics, except the second model. In case of the mathematical model with the assumption of pure shear of the glue layer a very significant shift of values of natural frequencies

and increase of piezoelectric damper or actuator efficiency were observed. These discrepancies are the results of the assumed simplifications of the real strain of the transducer and resulting generated shear stress in the glue layer. There was also an assumption about pure shear of the glue layer, while, in the real system, this layer is under the influence of forces that cause the eccentric tension of it.

4.1. Analysis of influence of the considered mechatronic system's parameters

Developed mathematical models of considered system were used to analyse influence of geometric and material system's parameters on obtained dynamic flexibility. This study was carried

out in dimensionless form in order to generalize obtained results. Results are presented in the form of three-dimensional graphs that show the course of the dimensionless absolute value of the dynamic flexibility in relation to dimensionless frequency of externally applied force and dimensionless value of one of the system's parameters. In Fig. 9 to Fig. 11 influence of the selected system's parameters on the dynamic flexibility for the first natural frequency are presented.

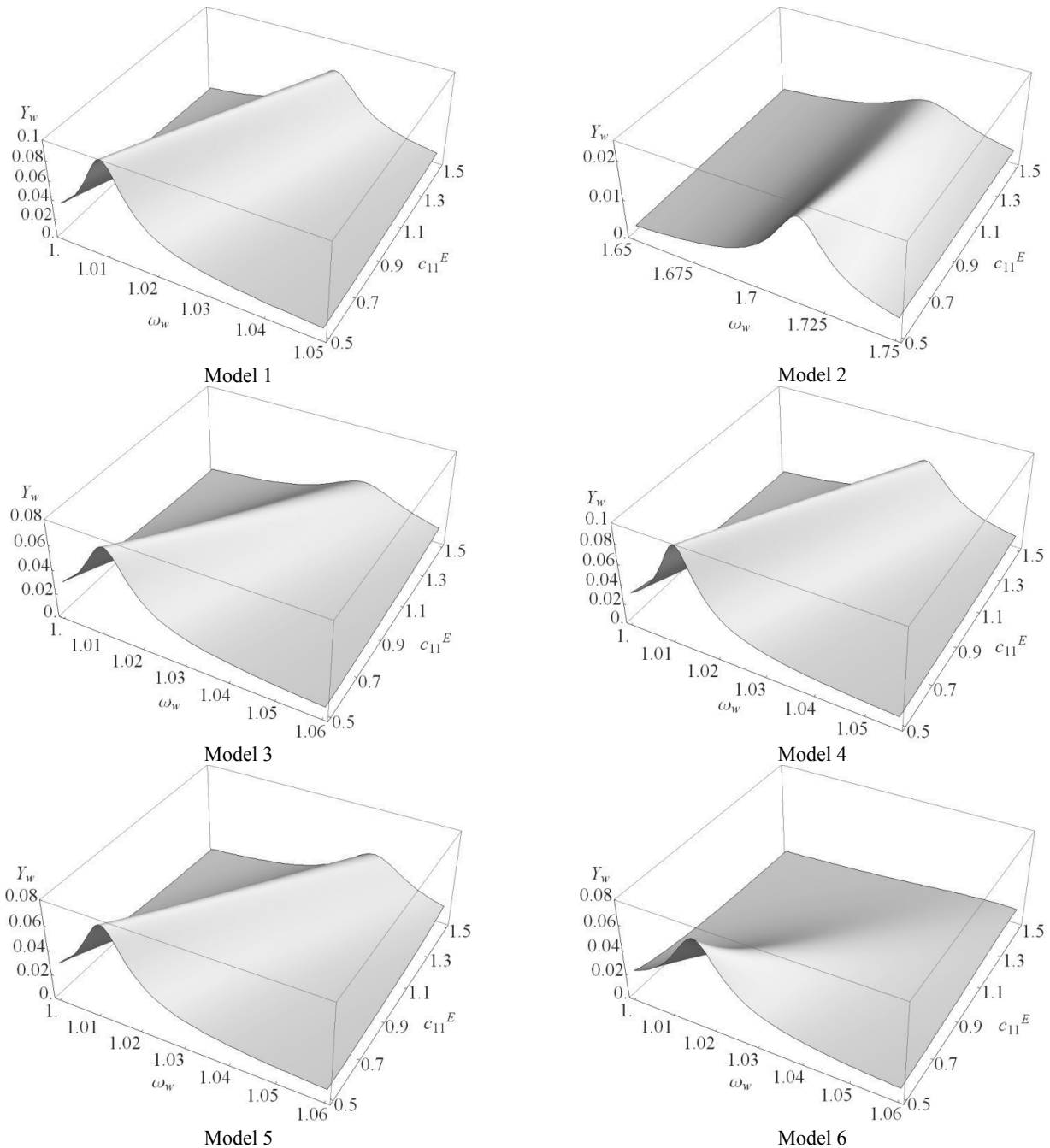

Fig. 10. Influence of the piezoelectric transducer's longitudinal modulus of elasticity on the absolute value of the dimensionless dynamic flexibility of the mechatronic system with piezoelectric vibration damper

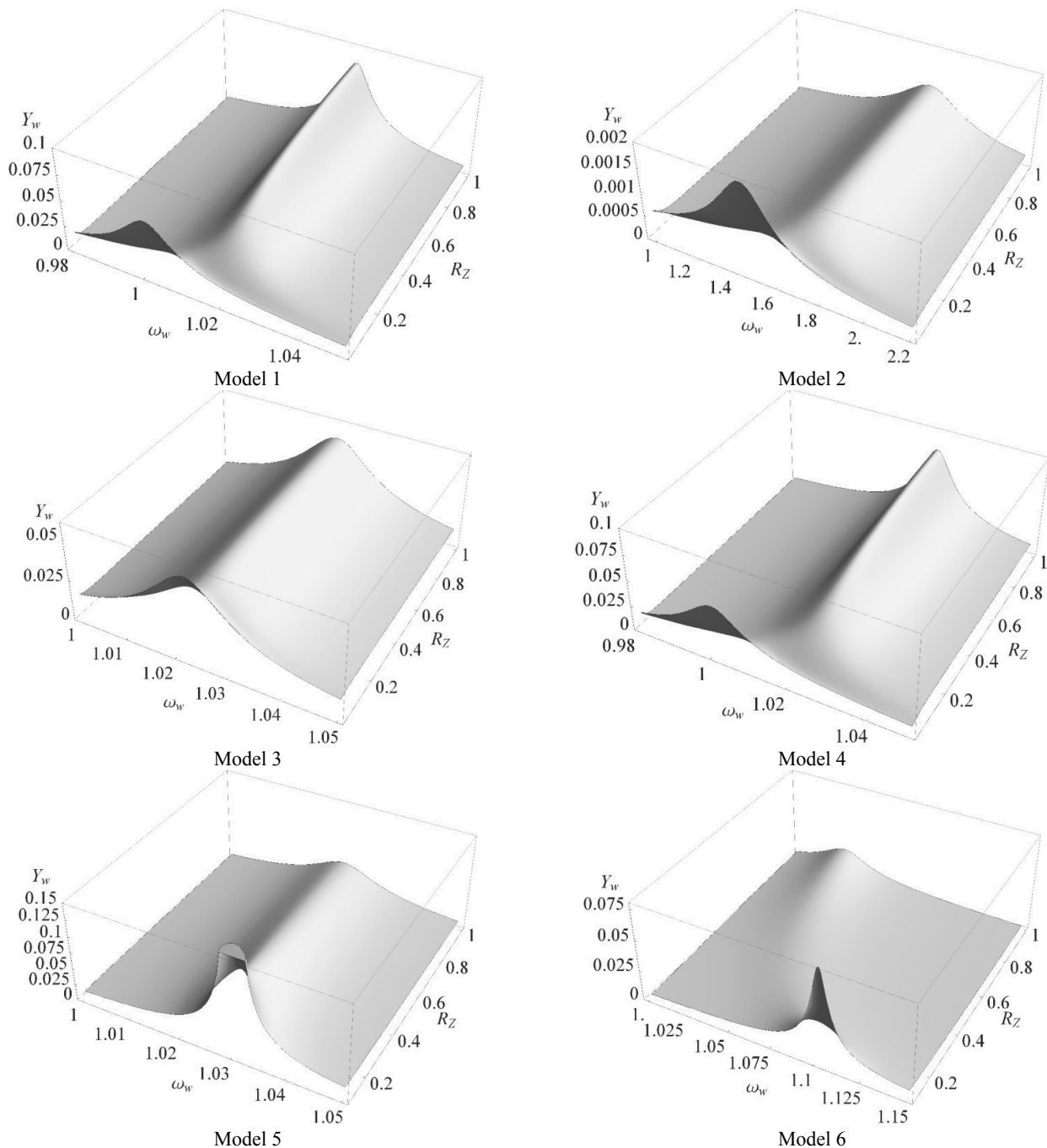

Fig. 11. Influence of the shunt circuit's resistance on the absolute value of the dimensionless dynamic flexibility of the mechatronic system with piezoelectric vibration damper

5. Conclusions

Realized studies have shown that the corrected approximate Galerkin method can be used to analyse mechatronic systems with piezoelectric transducers. Verification of the approximate method proved that obtained results can be treated as very precise.

The simplest is the mathematical model with the assumption about perfectly bonded piezoelectric transducer. But taking this assumption it is impossible to define influence of the glue layer on the dynamic characteristic of the system. Using this model it is not possible to meet requirements undertaken in this work. To take into account properties of the glue layer and its real loads to which it is subjected, mathematical models where an eccentric

tension of glue layer was considered were developed. Interactions between elements of the system were being taken into consideration and real strain of the transducer was determined. The third mathematical model is much more complex than the last one, while obtained results are very similar. It is therefore concluded that the optimal in terms of assumed criteria is the last mathematical model where a bending moment generated by the transducer and eccentric tension of a glue layer between the piezoelectric transducer and surface of the beam were taken into account. Using this model it is possible to analyse influence of all components of the system, including glue layer between the beam and transducer, while it is quite simple at the same time.

Acknowledgements

This research was supported by the Polish Ministry of Science and Higher Education - National Science Centre as a part of the research project No. N501 064440 (2011-2013).

References

- [1] S.O.R. Moheimani, A.J. Fleming, *Piezoelectric Transducers for Vibration control and Damping*, Springer, London, 2006.
- [2] W. Kurnik, P.M. Przybyłowicz, A. Tylikowski, *Torsional Vibrations Actively Attenuated by Piezoelectric System*, Proceedings of the 4th German-Polish Workshop on Dynamical Problems in Mechanical Systems, Berlin, 1995.
- [3] J.X. Gao, W.H. Liao, *Vibration analysis of simply supported beams with enhanced self-sensing active constrained layer damping treatments*, *Journal of Sound and Vibration* 280 (2005) 329-357.
- [4] A. Buchacz, M. Płaczek, *Damping of Mechanical Vibrations Using Piezoelements, Including Influence of Connection Layer's Properties on the Dynamic Characteristic*, *Solid State Phenomena* 147-149 (2009) 869-875.
- [5] N.W. Hagood, A. von Flotow, *Damping of structural vibrations with piezoelectric materials and passive electric networks*, *Journal of Sound and Vibration* 146/2 (1991) 243-268.
- [6] O.M. Fein, *A model for piezo-resistive damping of two-dimensional structures*, *Journal of Sound and Vibration* 310/4-5 (2008) 865-880.
- [7] W. Kurnik, *Damping of Mechanical Vibrations Utilising shunted Piezoelements*, *Machine Dynamics Problems* 28/4 (2004) 15-26.
- [8] A.J. Fleming, S. Behrens, S.O.R. Moheimani, *Optimization and implementation of multimode piezoelectric shunt damping systems*, *IEEE/ASME Transactions on Mechatronics* 7/1 (2002) 87-94.
- [9] S. Yoshikawa, A. Bogue, B. Degon, *Commercial Application of Passive and Active Piezoelectric Vibration Control*, Proceedings of the 11th IEEE International Symposium on Applications of Ferroelectrics, Montreux, Switzerland, 1998.
- [10] M. Pietrzakowski, *Active damping of beams by piezoelectric system: effects of bonding layer properties*, *International Journal of Solids and Structures* 38 (2001) 7885-7897.
- [11] A. Buchacz, M. Płaczek, *Development of Mathematical Model of a Mechatronic System*, *Solid State Phenomena* 164 (2010) 319-322.
- [12] A. Buchacz, *The supply of formal notions to synthesis of the vibrating discrete-continuous mechatronic systems*, *Journal of Achievements in Materials and Manufacturing Engineering* 44/2 (2011) 168-178.
- [13] S. Żółkiewski, *Dynamical flexibility of the free-free damped rod in transportation*, *Journal of Achievements in Materials and Manufacturing Engineering* 35/1 (2009) 71-78.
- [14] A. Dymarek, T. Dzitkowski, *Modelling and synthesis of discrete – continuous subsystems of machines with damping*, Proceedings of the 13th Scientific International Conference „Achievements in Mechanical and Materials Engineering” AMME’2005, Gliwice–Wisła, 2005, 217-220.
- [15] T. Dzitkowski, A. Dymarek, *Synthesis and sensitivity of machine driving systems*, *Journal of Achievements in Materials and Manufacturing Engineering* 20 (2007) 359-362.
- [16] K. Białas, *Reverse task of passive and active mechanical system in torsional vibrations*, *Journal of Achievements in Materials and Manufacturing Engineering* 35/2 (2009) 129-137.
- [17] A. Buchacz, A. Wróbel, *Modelling of complex piezoelectric system by non-classical methods*, *Journal of Achievements in Materials and Manufacturing Engineering* 35/1 (2009) 63-70.
- [18] K. Białas, *Computer-aided analysis and synthesis of branched mechanical systems*, *Journal of Achievements in Materials and Manufacturing Engineering* 45/1 (2011) 39-44.
- [19] K. Białas, *Computer-aided synthesis and analysis of discrete mechanical systems*, *Journal of Achievements in Materials and Manufacturing Engineering* 38/2 (2010) 171-178.
- [20] <http://www.ferroperm-piezo.com/>
- [21] S. Behrens, A.J. Fleming, S.O.R. Moheimani, *A broadband controller for shunt piezoelectric damping of structural vibration*, *Smart Materials and Structures* 12 (2003) 18-28.
- [22] N.D. Maxwell, S.F. Asokanathan, *Modal characteristics of a flexible beam with multiple distributed actuators*, *Journal of Sound and Vibration* 269 (2004) 19-31.
- [23] A. Preumont, *Vibration Control of Active Structures: An Introduction*, Kluwer Academic Publ., 2002.
- [24] A. Buchacz, M. Płaczek, *Characteristic of the mechatronic system with piezoelectric actuator modelled as the combined beam*, Proceedings of the 15th International Conference “Modern Technologies, Quality and Innovation” ModTech 2011, Vadul lui Voda, Chisinau, Republic of Moldova, 2011, 133-136.
- [25] A. Buchacz, M. Płaczek, *Modelling and testing of one-dimensional vibrating mechatronic systems*, The Silesian University Publishing House, Gliwice, 2011 (in Polish).