

Examinations on retention of overdentures with elastic frictional attachments

W. Chladek ^a, G. Chladek ^{a,*}, M. Wrzuś-Wieliński ^b, J. Żmudzki ^a

^a Department of Technology of Materials, Silesian University of Technology, ul. Krasińskiego 8, 40-019 Katowice, Poland

^b Silesian Centre for Dental Implantology, ul. 3 Maja 7, 44-200 Rybnik, Poland

* Corresponding author: E-mail address: chladek@interia.pl

Received 22.09.2010; published in revised form 01.11.2010

Properties

ABSTRACT

Purpose: of this paper was to evaluate the effectiveness of the overdentures equipped with silicone elastic frictional attachments.

Design/methodology/approach: The examinations of retention characteristics of traditional attachments, elastic frictional attachments and models of overdentures have been carried out using Zwick testing machine. Retention forces and work essential for separating the attachments have been determined as well. Next the force – displacement characteristics for overdenture model have been registered for two places where the force was applied and for three inclination angles of the line of application of force.

Findings: The obtained results of laboratory examinations gave evidence of high effectiveness of elastic frictional attachments.

Research limitations/implications: It has not been possible to register mechanical characteristics due to limitations of clinical conditions. Wide analysis of retention characteristics requires examinations carried out in laboratory conditions.

Practical implications: Thorough analysis of force - displacement characteristics enables to understand better the mechanisms which are essential for the effectiveness of particular attachments. Applying such knowledge in practice helps to use more effectively the properties of silicone rubbers for making the elastic frictional attachments.

Originality/value: The presented method of evaluating the effectiveness of attachments is based on determining retention work of the attachments and it allows to compare quite objectively even relatively different solutions. The so far used criterion of measuring vertical retention force makes it possible to compare only the solutions which are based on similar mechanical principles.

Keywords: Mechanical properties; Biomaterials; Overdenture; Implant; Attachment

Reference to this paper should be given in the following way:

W. Chladek, G. Chladek, M. Wrzuś-Wieliński, J. Żmudzki, Examinations on retention of overdentures with elastic frictional attachments, Journal of Achievements in Materials and Manufacturing Engineering 43/1 (2010) 205-213.

1. Introduction

Commercially offered systems of attaching overdenture were very efficient initially but when they were used for a long period of time it was not possible to avoid some problems with the atrophy of alveolar ridge. Attachments with shock absorbing buffer are not sufficient if the process of atrophy is quite advanced. In such cases the buffer is not able to deform and the denture needs to be rebased. Introducing the elastic frictional attachment seems to be a good solution since it has a direct contact with the integrated abutment (IA) or abutment [1]. The principle of functioning of the attachment has been presented in Fig. 1. It assumes that the retention element (matrix) is an integral part of a soft liner of an ordinary acrylic denture. Retention is guaranteed by a hole in a soft liner which is undersized to the diameter of IA. It allows to form insertion which generates an implant-silicone rubber frictional connection. Adequately chosen geometry and specific material properties of silicone enable the process of elastic strain of the element in accordance with mucosa resilience of the bearing area. A hole milled in acrylic denture facilitates the use of elastic properties of silicone rubber very effectively and therefore it reduces load of the implant and the tissues around the implant [1]. Such attachment mainly stabilizes the denture whereas the occlusion forces are transferred mostly by the denture base to tissues of the bearing area. Uniformly loaded bearing area ought to slow down the course of atrophy of the alveolar ridge [1,2] and to prevent some possible damages of dentures and overloaded implants [2-4]. The additional advantage of a suggested solution is the fact that denture can adjust to the existing height of the alveolar ridge (in case of atrophy) or to the thickness of mucosa and therefore rebasing is not necessary. Such effect can be achieved when friction forces between the elements of the attachment, the stiffness of elastic element (rubber) and resilience of the bearing area are related correctly. Laboratory tests gave clear evidence that mechanical durability of elastic frictional attachments is sufficient to guarantee their proper functioning even for four years [5].

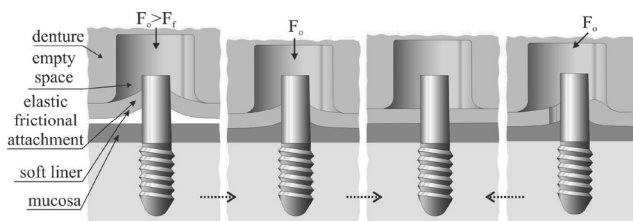

Fig. 1. Structure and principle of operation of elastic frictional attachment with conceptual presentation of reactions at different types of applied load

The presented design of attachment operates on different principles than those applied in bar attachments and ball attachments. The two latter ones can only make a stiff connection of denture with a pillar. A design with bar attachments can be a good example to illustrate that any turn related to the axis of a bar pulls out the clips which are positioned on a bar and it causes immediate removal of a denture. Such turn for example can be made by a denture in the area of molar teeth by a slight movement

of tongue or when the denture is strained excessively in the area of incisors. This will not happen when elastic attachments are applied because the elastic material, i.e. silicone rubber which has been used, gives a chance to keep their considerable ability of reversible strain both at side and vertical movements of a denture and when it moves along the axis of integrated abutment at work (Fig. 1). Therefore the measurements of retention forces cannot be a reliable criterion for comparing such diverse retention elements because that criterion does not take into consideration the course of force-displacement characteristics but only the instantaneous mechanical state of attachment. The objective verification of effectiveness of different types of connections is possible only when the characteristics have been analyzed and other criterion has been introduced. Such criterion should take into account both measured physical quantities because they influence the quality of the attachments. The best criterion seems to be work which ought to be done in order to separate the attachment.

However it should be remembered that the force acting at the attachment is only one component which prevents releasing of the denture. Detailed analysis of retention characteristics of the attachments is only possible in the process of laboratory examinations carried out on phantom models which simulate the actual features of the base. These models give the opportunity to examine and understand better the phenomenon of retention, taking into account such factors as e.g. adhesion forces, distribution of forces at alveolar ridges which support the denture at the base. It can be assumed, that appropriate examinations carried out on phantoms illustrate the actual performance of a system at work.

2. Materials and experimental procedure

The investigations of retention characteristics of attachments have been carried out on Zwick testing machine. Two types of commercially used attachments have been used in the first stage of examinations:

- ball attachment with a ball of 2.5 mm diameter with a plastic clip (Fig. 2a)
- bar attachment – a bar of 1 mm wide base with a head of 1.8 mm diameter and a plastic clip (Fig. 2b).

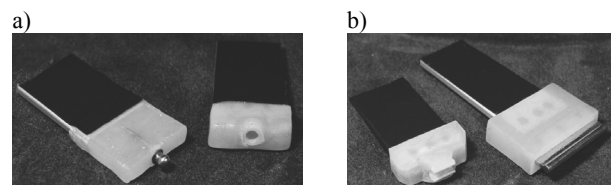

Fig. 2. Samples for investigating retention forces of commercially used attachments: ball attachment with a ball of 2.5 mm diameter (a) and attachment with a plastic clip (b)

All the elements of the attachments have been seated on acrylic base and fixed to a duralumin flat bar so that they could be fastened tightly in the jaws of a tester.

In order to investigate the retention characteristics of elastic frictional attachments a special holder for fixing the tested samples and carrying out the tests has been designed (Fig. 3). The holder enables to keep the alignment of force which expands the attachment. The impact of the introduced saliva between the interacting surfaces is essential for monitoring friction forces when the frictional elements (IA and silicone rubber) have been attached. Therefore a special holder has been equipped with a chamber filled with artificial saliva. Implant models with endings which simulated integrated abutments (IA) of selected one stage implants: Garbaccio, Q-Implant, Alpha-Bio have been used in the tests. Technical criteria such as cylindrical or conical shapes of IA, easy and stable way of placing them in the attachment have been taken into consideration while choosing the tested implants. Three analogues of different diameters and geometry of a part corresponding to IA of the real implant have been made after thorough analysis of geometric features of implants (Fig. 3):

- analogues of cylindrical geometry of integrated abutment (CIA) $\phi=2.5$ mm;
- analogue of cylindrical-conical geometry of integrated abutment (CCOIA) $\Phi=3.5$ mm;
- analogue of conical geometry of integrated abutment (COIA) $\Phi=3.5$ mm.

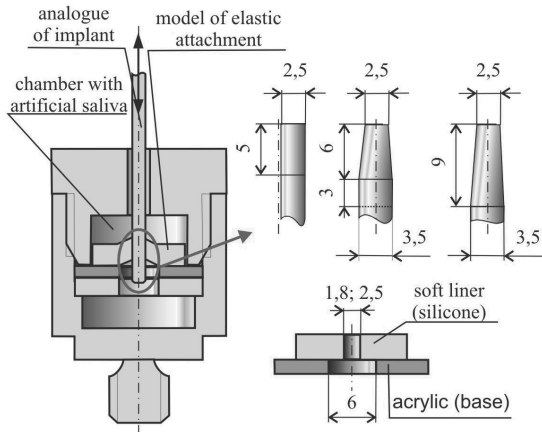

Fig. 3. Holder for investigating retention characteristic of elastic frictional attachments and geometry with essential dimensions of samples which simulate one stage implants and elastic element models

All the samples in a frictional attachment which simulate implants have been made of Ti6Al4V titanium alloy and their surface has been polished.

Silicone Molloplast B utilized for making the attachments has been selected in mechanical property tests carried out for some commonly used soft liners. It had the best properties when it was compressed, its characteristic was close to a linear one and it also had the shortest stress relaxation time. Some examples of stress – strain characteristics and stress relaxation curves of Molloplast B have been presented in Fig. 4 and Fig. 5.

Analogues of elastic retention element have been made of silicon rubber joined with acrylic base (Fig. 3). A hole which was

centric and undersize to the diameter of IA has been made in the models. Its diameter was:

- 1.8 mm for CIA type of analogues,
- 2.5 mm for COIA or CCOIA type of analogues.

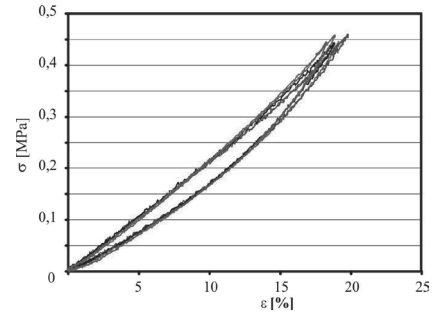

Fig. 4. Stress – strain characteristics obtained for Molloplast B samples

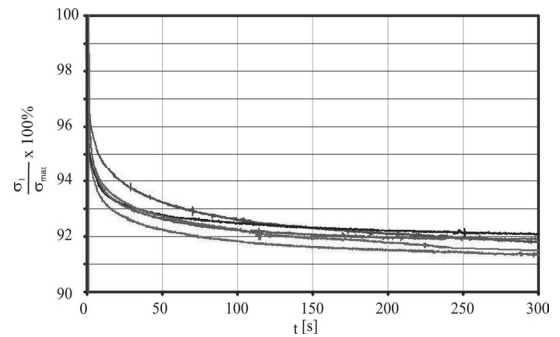

Fig. 5. Relaxation curves obtained for Molloplast B samples

An example of retention characteristics for commercially used attachment has been presented in Fig. 6. New attachments were connected and disconnected fifteen times before the tests began. The attachments were expanded in the tests and changes of force in the function of displacement while moving up the retention element have been registered. The velocity of the cycle was 5 mm/min. The test was carried out five times for each type of attachment and retention force (F_R) mean value has been calculated. The maximal value of force was assumed to be F_R . The obtained results have been read in the calculation sheet. Areas under the diagrams have been counted and thus work essential for separating the attachments has been determined. While analyzing the course of characteristics, total work (W_T) for a ball attachment and a bar attachment has been divided into two basic areas (Fig. 6):

- the area of WE - effective work of the attachment; in this part of retention characteristic the attachment transfers the load in an effective way; at the first stage automatic return of the retention element to the initial position is possible after the load has been removed, whereas in the second stage (after F_R has been exceeded) the return can be caused by applying slight force; the attachment is stabilized;

- the area of WS - separation work; the area of the instability of attachment; in real conditions there is „automatic” separation because elasticity force of the retention element is greater than friction force responsible for the retention of attachment and that is why a bar or a ball is pushed out of the retention element and so pace of the process helps the patient to react.

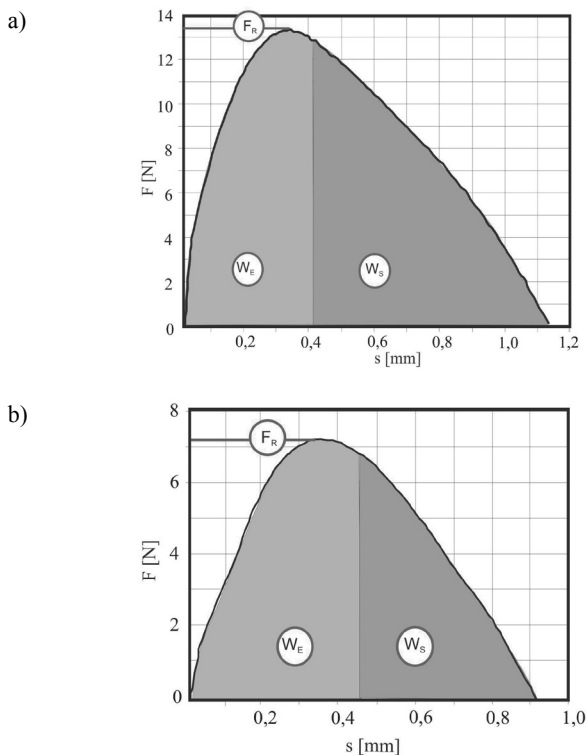

Fig. 6. Exemplary retention characteristics for a ball attachment (a) and bar attachment with a polymer clip (b) with marked areas of W_E and W_S

During the tests of elastic frictional attachments the force generated while the titanium sample was moved in the attachment and its displacement have been registered. The velocity of a cycle was 15 mm/min. An exemplary full mechanical characteristics together with the presentation of a concept of particular stages of work of the attachment have been presented in Fig. 7. Four initial cycles of 2.5 mm displacement value have been made in each test after the first stage when the model of implant was placed in the hole. It ensured the stability of attachment and provided stress relaxation of the compressed silicone rubber. During the fifth cycle a titanium sample was taken out from the membrane (it came back to its initial position). Part of the last cycle, starting from the position of equilibrium ($F = 0$ N) until all the interacting elements were separated, was assumed to be retention characteristics of the attachment in the carried out analysis (Figs. 7 b-d). Such presentation of retention characteristics corresponds to the actual functioning of the retention element while the implant is being removed by force parallel to IA axis, as

it is in the case of measurements carried out for commercial attachments. The F_R of the examined attachments is the value of registered force which causes d_{FR} maximal deflection of the elastic membrane; in that moment friction force (F_F) is overcome and the movement of the analogue against the elastomeric membrane begins (Fig. 7a).

W_T work for the elastic frictional attachments has been divided into the following characteristic areas (Figs. 7 b,c,d):

- the area of WEL - work of elastic strain of the retention element; in this part of retention characteristics IA does not move against the elastic attachment and when load has been removed the attachment „automatically” returns to its initial position;
- the area of WF - friction work; determined when analogues of CIA type are applied; when friction force has been overcome then a titanium sample moves against the retention element (in real conditions the retention element together with the denture moves against IA), the surface of the real contact of IA with silicone rubber does not decrease, a return to the initial position can occur but not automatically, only when the applied force acts in opposite direction and it exceeds the value of friction force;
- WRF - remaining friction work; the analogue moves against the retention element, in CCOIA and COIA analogues the size of insertion decreases (Figs. 7c-d), the surface of the real contact between IA and silicone rubber decreases due to the fact that the sample moves out from the attachment, a return to the initial position is still possible after applying force greater than friction force.

The examinations of retention characteristics of the model of overdenture equipped with two elastic frictional attachments have been carried out on a model presented in Fig. 8. The model of denture bearing area in the part corresponding to the area of denture contact with alveolar ridge has been covered by 2 mm layer of Ufi Gel P silicone which simulated the mucous membrane. The axes spacing of implant models was 20 mm. The examinations were carried out for CCOIA type of silicone attachment which was chosen on the basis of the analysis of retention characteristics of the attachments. The model of denture bearing area was fixed to a platform of CL-MT paralelometre produced by Heraeus which was then fixed by a magnetic holder on a table under the upper holder of a testing machine (Fig. 9a). During the tests a spherical joint of paralelometre enabled to position the platform in such way that the line of acting of the force relative to the bite plane was 90° , 60° and 30° successively.

Elastic frictional attachments in overdenture models made of Molloplast B have been integrated with a soft liner. The thickness of silicone was 2.5 ± 0.1 mm and the undersize holes in elastomer attachments were of 2.5 mm diameter (i.e. matched to the shape of CCOIA). Seats of 6 mm diameter have been milled in the denture and they made it possible to keep the features of a membrane spring which, in turn, conditions proper work of the dentures.

The models have been loaded in a Zwick universal testing machine using a 50 cm long cord attached to a movable holder of the machine and the other end was fixed in the dental arch. The cord was hitched between incisors and premolar teeth in the zone of the neck of teeth (Fig. 9b) in such way that it imitated quite accurately the pressure of tongue on the denture .

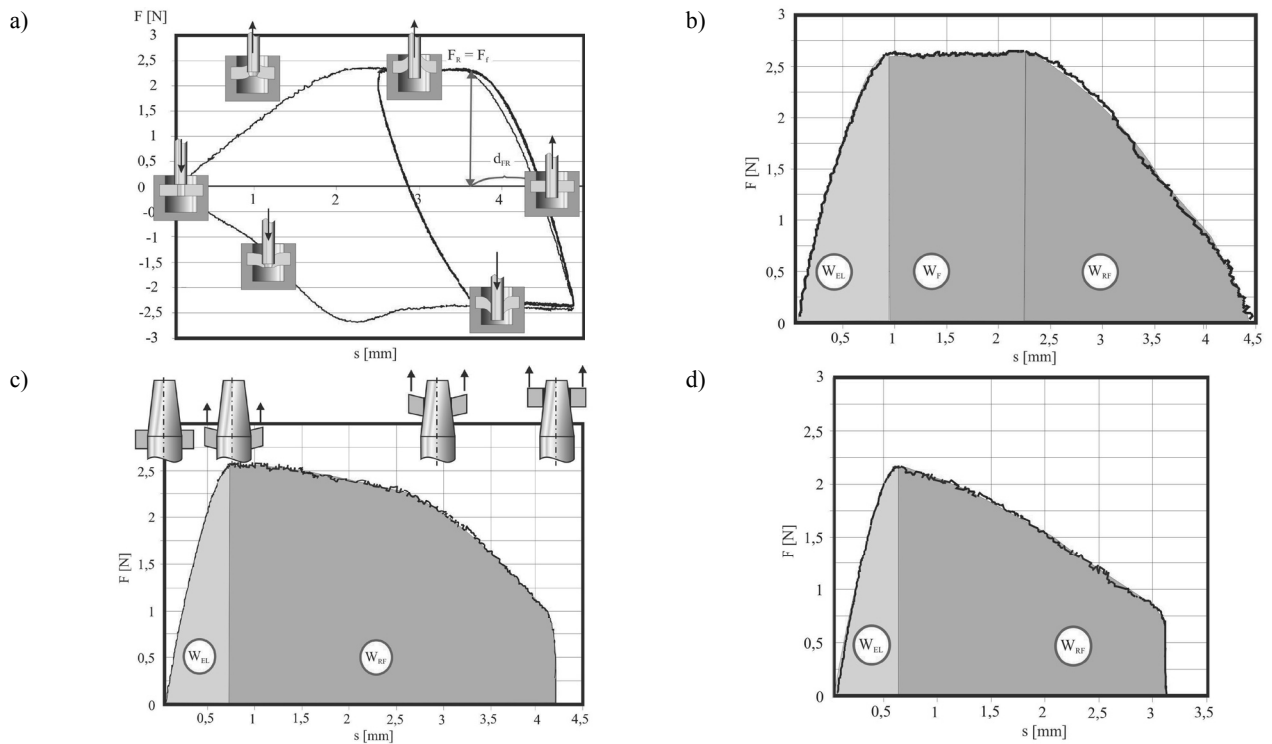

Fig. 7. Exemplary mechanical characteristic for a models of elastic frictional attachments: complete characteristic with conceptual presentation of analogue movements in the attachment (a) and retention characteristic with marked areas of W_{EL} , W_F , W_{RF} (b) for elastic frictional attachment using CIA analogue, exemplary retention characteristics for elastic frictional attachments using CCOIA (c) and COIA (d) analogues with marked areas of W_{EL} and W_{RF}

Force – displacement characteristics of the denture against the bearing area (by registering a shift of the upper holder) have been registered. The velocity of displacement of the upper catch (pulling catch) of the testing machine was 40 mm/min. Each test was repeated five times. Mean values of F_{RD} force which was removing the denture and standard deviation for the series of five measurements were determined (F_{RD} - maximum values of removing force determined for overdenture models; retention force for overdenture models). It should be kept in mind that the results of measurements contain an error resulting from deformation of the cord which was used for loading. However the aim of the examinations was to evaluate the removing forces and to illustrate the performance of the attachments at work therefore the error was left without any correction and interpretation.



Fig. 8. Phantom model with implant models of CCOIA type

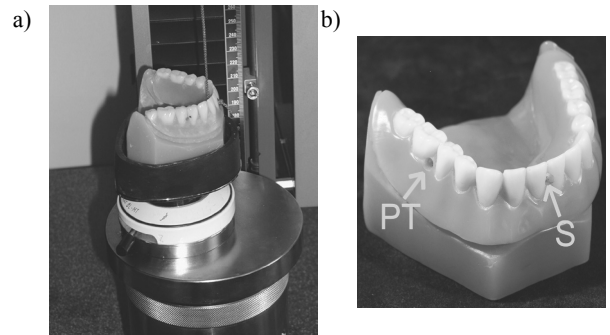

Fig. 9. Phantom model at a measuring stand (a) and the way of distributing the points where the cord for loading the model was hitched (b)

3. Results and discussion

In the carried out tests, the highest value of F_R mean of 13.34 N has been registered for a ball attachment with a ball of 2.5 mm diameter. The value of F_R mean was 7.23 N for the bar attachment with a polymer clip as the retention element. The highest value of W_E , regarding the part of characteristics which is

responsible for effective functioning of the attachment is 4.05 mJ and it has been obtained for a ball attachment. The value of W_E was 2.67 mJ for a bar attachment. These results showed similar effectiveness of the tested attachments as F_R values investigations did. The results have been listed in Table 1.

Table 1.

Average value of retention forces and retention works with standard deviations for selected commercially used attachments

| Types of attachment: | F_R [N] | $W_E \times 10^{-3}$ [J] | $W_S \times 10^{-3}$ [J] | $W_T \times 10^{-3}$ [J] |
|----------------------|------------|--------------------------|--------------------------|--------------------------|
| ball | 13.34 | 4.05 | 5.38 | 9.43 |
| attachment | ± 0.31 | ± 0.1 | ± 0.09 | ± 0.11 |
| bar | 7.23 | 2.67 | 1.41 | 4.08 |
| attachment | ± 0.25 | ± 0.06 | ± 0.08 | ± 0.08 |

The mean values of F_R for elastic frictional attachments were in the range of 2.18 to 2.6 N. The obtained F_R values were significantly lower than those of traditional designs. The mean values of total work done by elastic frictional attachments were in the range of 4.46 mJ in the least favorable design with applied analogue of COIA type, up to 8.71 mJ when analogue of CCOIA were used. Accurate presentation of the obtained results has been given in Table 2.

Table 2.

Average values of retention forces and retention works with standard deviations for the elastic frictional attachments

| Type of IA | CIA | CCOIA | COIA |
|-----------------------------|-----------------|-----------------|-----------------|
| F_R [N] | 2.42 \pm 0.09 | 2.6 \pm 0.13 | 2.18 \pm 0.15 |
| $W_{EL} \times 10^{-3}$ [J] | 1.44 \pm 0.06 | 1.11 \pm 0.11 | 0.73 \pm 0.06 |
| $W_F \times 10^{-3}$ [J] | 3.76 \pm 0.1 | x | x |
| $W_{RF} \times 10^{-3}$ [J] | 2.92 \pm 0.08 | 7.60 \pm 0.17 | 3.73 \pm 0.14 |
| $W_T \times 10^{-3}$ [J] | 8.12 \pm 0.13 | 8.71 \pm 0.16 | 4.46 \pm 0.22 |

The measurements of retention forces of commercially used implant attachments are usually carried out simultaneously with durability tests in vitro. It has been presented in paper [7] that the value of F_R of 15.3 N was reached in new bar attachments with two metal clips and F_R was 13.7 N when two plastic clips were used. Retention force of a bar attachment with a single cast clip holder which was measured and then presented in paper [6] came up to 25.2 N for the new attachment whereas for the 'stabilized' one (after fifteen separations) it was 8.6 N. Six commercially used ball attachments were tested and the results have been presented in paper [8] – the results were within the range of 8.2 N up to 14.0 N. Similar values of F_R were reached during in vitro tests of dentures with bar attachments 32.9 N \pm 9.1 N or with ball attachments 31.4 N \pm 8.3 N [9]. These results correspond to the results presented in this paper for commercially used designs. However F_R values for elastic frictional attachments were few times lower and this can be clearly seen in Fig. 10. A phenomenon of gradual decreasing of the registered force while the analogue moves against the elastic element can be noticed in elastic attachments. Such effect results from the fact that the insertion is getting smaller until the last phase of the cycle is ended up with a sudden loss of stability of the attachment. This happens when the elastic element 'separates' from the conical part of a model.

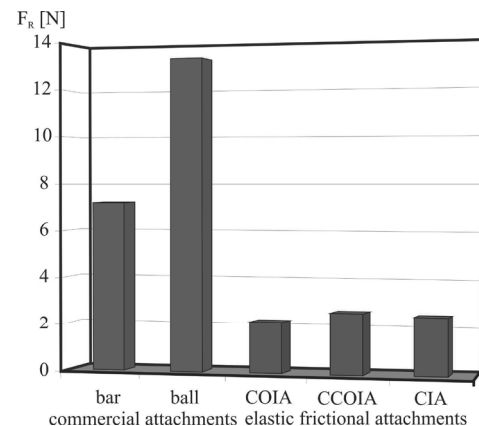

Fig. 10. A comparison of the average value of retention forces for the examined types of attachments

The method of F_R measurement applied in investigations, like most presented results of measurements in technical literature, is based on measurements of maximal force which disconnects the attachment and acts in direction which is in accordance with the axis of implant [10-14]. Although there are some methodological differences, such research methodology give a chance to compare the attachments of similar character which operate on similar principles. However the values of displacement of particular elements of the attachment against one another before it loses its stability are very rarely considered in the discussion of investigation results [15]. So far there have been no elaborations regarding that problem which is also important as far as the quality of the attachments is concerned. The traditionally applied designs such as bar and ball attachments feature „stiff” mechanical characteristics, i.e. at reasonably high retention force, the relative displacement of matrix and patrix before the attachment is separated is very small. The analysis of characteristics presented in Fig. 6 reveals that even the slightest (0.4-0.5 mm) vertical displacement of a clip results in loss of stability of the attachment. That is why F_R is a good criterion to compare these types of attachments relatively well. However it needs to be remembered that it is a big simplification since the real course of mechanical characteristics is not taken into account. The actual effectiveness of the attachment depends not only on retention force but also on the distance covered by retention elements against one another before they lose stability. As far as the elastic attachments featuring „soft” characteristics are concerned, vertical movement, essential for separating the connections, ranged from 3 mm to about 4.5 mm which is six to eleven times more than in commercially used designs. That is why an objective comparison of attachments with one another can be possible only after mechanical characteristics have been analyzed and both most important parameters have been considered. It can be done by calculating the areas under the diagram. The calculated work gives information how much energy needs to be provided to separate the attachment. The interpretation of obtained results is made possible by dividing the diagrams of displacement – force characteristics into the areas related to their instantaneous mechanical state by distinguishing the types of work responsible for effective and stabilized functioning of the analyzed elements: W_E for traditional attachments and W_T for elastic frictional attachments. A summarizing list of compared values for the examined attachments has been presented in Fig. 11.

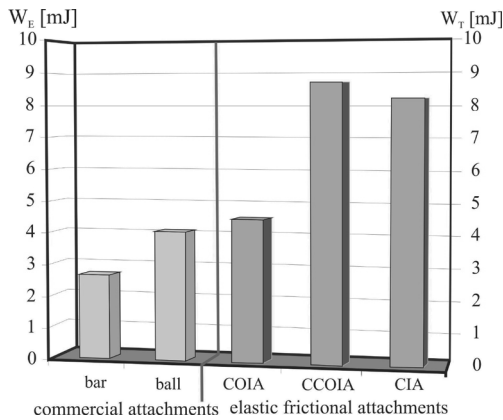

Fig. 11. A comparison of the average value of retention forces (a) and W_E with W_T (b) for the examined types of attachments

The values of W_T of the elastic attachments approximated the values of W_T obtained for commercial attachments and they were higher than the values of W_E work responsible for functioning of

the traditional designs. On the basis of this criterion it can be seen that despite the fact that retention forces are lower in elastic attachments, yet the attachments are more difficult to pull apart. The use of specific properties of silicone rubber such as high elasticity, small values of friction forces between rubber and the implant in attachments of that type with considerably extended distance necessary for separating the attachment (movement of a silicone attachment against the implant) allows to consider the whole area of characteristics as the area of effective functioning. Even in the final area of characteristics where friction forces begin to decrease, the loss of stability cannot start automatically without making a decisive move. Removing load will result in regaining a part of energy of the attachment just like in spring reaction (W_S work), whereas the application of force (in opposite direction) bigger than friction force will cause a return of the attachment to the initial position. Comparable results of the investigations of traditional attachments have been obtained only for the analogues of COIA type for which the distance of friction is short due to geometry of the analogue. It should be noticed that even a slight extension (about 1 mm) of cylindrical IA fragments which interact actively with silicone rubber could facilitate 20 – 30 % increase of the value of W_T , due to the process of ‘expansion’ of the most effective parts of characteristics with W_F .

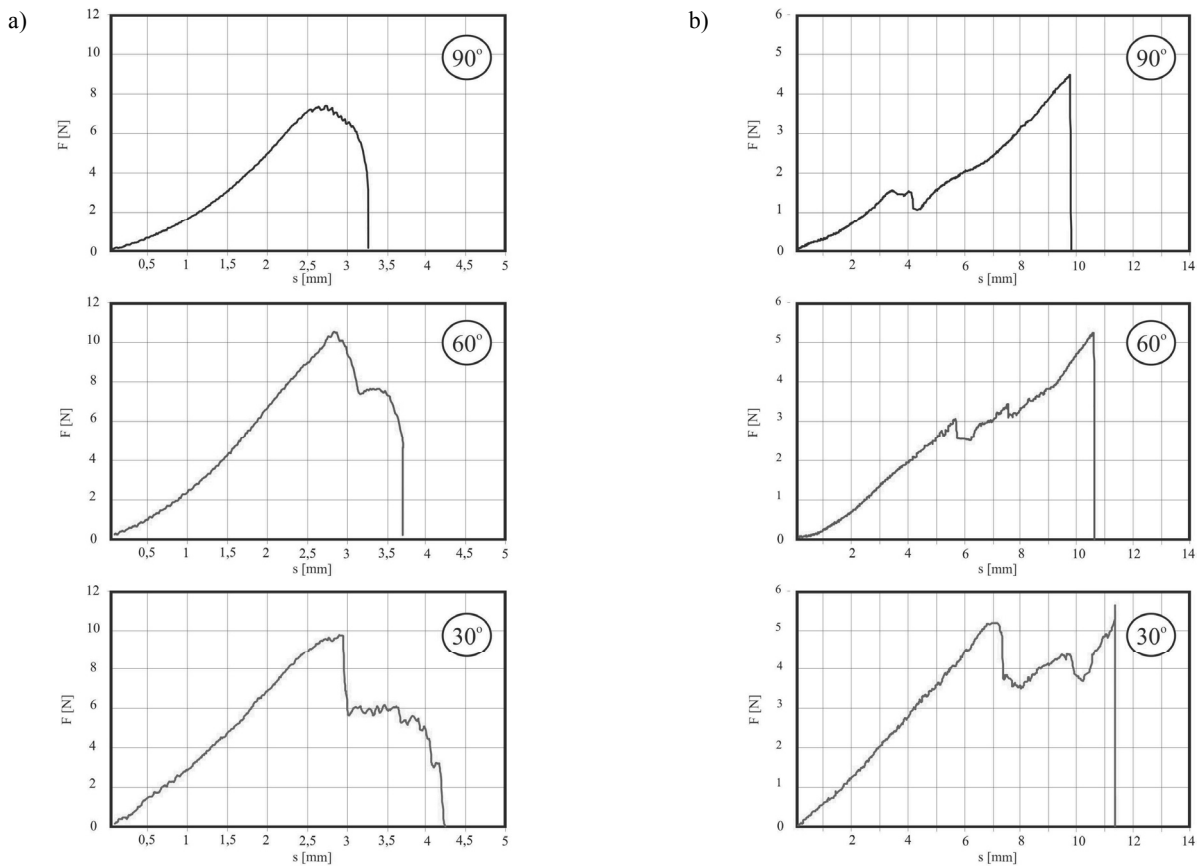

Fig. 12. Characteristics of removing forces depending on the of displacement obtained for the model of overdentures with load applied in incisors zone (a) and premolar teeth zone (b) for three directions of acting of the removing force

The examples of retention characteristics obtained for overdenture model with implant models of CCOIA type have been presented in Fig. 12. Mean values of the obtained F_{RD} have been listed in Table 3.

Table 3.

Mean values of maximum removing force F_{RD} determined for overdenture models depending on the angle of acting of the force

| The angle of acting of the force | F_{RD} [N] | |
|----------------------------------|--------------|-----------|
| | incisors | premolars |
| 90° | 7.4±0.46 | 4.44±0.51 |
| 60° | 10.2±0.85 | 5.25±0.68 |
| 30° | 9.91±0.91 | 5.97±0.59 |

In the majority of cases deviation of the direction of acting of the force from the path of inserting the denture resulted in the increase of the value of removing force. This phenomenon seems to be quite advantageous because it impedes the process of removing denture by acting of forces of the tongue and tension of the lip. A significant rate of displacement, preceding removing of the denture from the models of implants which can be seen on the characteristics is very important for functioning of the discussed conception of implant retained denture. Elastic properties if silicone made it possible to obtain such quality. It is particularly advantageous at side loads since the attachment provides total mucous support which eliminates overloading of the implants. The presented characteristics, particularly at side loading which correspond to the process of chewing, show that there are some moments of gradual loss of retention by the first and then the second attachment. Therefore it is possible for the patient to foresee a complete breaking of the denture and to get back to the initial state by changing the conditions of load.

4. Conclusions

The presented results of investigations and their interpretation lead to the following conclusions:

- 1) The suggested new type of evaluating the effectiveness of implant attachments which is based on determining and analyzing the successive phases of total work of the attachment allows to carry out an objective comparison of different designs of attachments for overdenture;
- 2) A comparison carried out on the basis of the determined retention work in traditional attachments and elastic frictional attachments gave evidence that the suggested type of attachment makes it possible to obtain very good conditions of retaining the overdenture;
- 3) Basing on the examinations of retention characteristics of overdenture models it has been revealed that throwing the denture from the bearing area is preceded by a considerable displacement of the denture to implants. This phenomenon is particularly advantageous in the case when there are side

loads because it prevents the implants from becoming overloaded;

- 4) Retention force is a simplified criterion which enables to compare with one another the attachments which feature alike stiff mechanical characteristics in an easy way.

References

- [1] W. Chladek, G. Chladek, T. Lipski, J. Margielewicz, J. Żmudzki, Biomechanical problems related to design of implantological overdenture stabilization system, Silesian University of Technology Publishing House, Gliwice, 2008 (in Polish).
- [2] M.I. Macentee, J.N. Walton, N. Glick, A clinical trial of patient satisfaction and prosthodontic needs with ball and bar attachments for implant-retained complete overdentures: Three-year results, *Journal of Prosthetic Dentistry* 93 (2005) 28-37.
- [3] J.N. Walton, S.C. Huizinga, C.C. Peck, Implant angulation: a measurement technique, implant overdenture maintenance, and the influence of surgical experience, *International Journal of Prosthodontics* 14 (2001) 523-530.
- [4] G.K. Watson, A.G. Payne, D.G. Purton, W.M. Thomson, Mandibular overdentures: comparative evaluation of prosthodontic maintenance of three different implant systems during the first year of service, *International Journal of Prosthodontics* 15 (2002) 259-266.
- [5] G. Chladek, Durability evaluation of a friction couple intended for implantological stabilization of complete dentures. *Acta of Bioengineering and Biomechanics* 10/3 (2008) 7-12.
- [6] L. Breeding, D. Dixon, S. Schmitt, The effect of simulated function on the retention of bar-clip retained removable prostheses, *The Journal of Prosthetic Dentistry* 75/5 (1996) 570-573.
- [7] J.N. Walton, N.D. Ruse, In vitro changes in clips and bars used to retain implant overdentures, *Journal of Prosthetic Dentistry* 74/5 (1995) 482-486.
- [8] K. Wolf, K. Ludwig, H. Hartfil, M. Kern, Analysis of retention and wear of ball attachments, *Quintessence International* 40/5 (2009) 405-412.
- [9] F. van Kampen, M. Cune, A. van der Bilt, F. Bosman, Retention and postinsertion maintenance of bar-clip, ball and magnet attachments in mandibular implant overdenture treatment: an in vivo comparison after 3 months of function, *Clinical Oral Implants Research* 14/6 (2003) 720-726.
- [10] W. Sadig, A comparative in vitro study on the retention and stability of implant-supported overdentures, *Quintessence International* 40/4 (2009) 313-319.
- [11] C.E. Besimo, A. Guarneri, In vitro retention force changes of prefabricated attachments for overdentures, *Journal of Oral Rehabilitation* 30/7 (2003) 671-678.
- [12] D.M. Botega, M.F. Mesquita, G.E. Henriques, L.G. Vaz, Retention force and fatigue strength of overdenture

- attachment systems, *Journal of Oral Rehabilitation* 31 (2004) 884-889.
- [13] O. Fromentin, C. Lassauzay, S. Abi Nader, J. Feine, R.F. de Albuquerque Jr., Testing the retention of attachments for implant overdentures - validation of an original force measurement system, *Journal of Oral Rehabilitation* 37 (2010) 54-62.
- [14] C.A. Svetlize, E.F. Bodereau Jr., Comparative study of retentive anchor systems for overdentures, *Quintessence International* 35 (2004) 443-448.
- [15] K.H. Chung, C.Y. Chung, D.R. Cagna, R.J. Cronin, Retention characteristics of attachment systems for implant overdentures, *Journal of Prosthodontics* 13 (2004) 221-226.