

Technical project management using quality methods

A. Gwiazda*

Institute of Engineering Process Automations and Integrated Manufacturing Systems, Silesian University of Technology, ul. Konarskiego 18a, 44-100 Gliwice, Poland

* Corresponding author: E-mail address: aleksander.gwiazda@polsl.pl

Received 14.10.2008; published in revised form 01.12.2008

Industrial management and organisation

ABSTRACT

Purpose: The paper presents the results of investigations of new methods that could be utilized in a technical project management. These methods base on the classical quality tools which have been modified to fulfil new technical requirements.

Design/methodology/approach: The empirical researches allow proposing a new formula of classical quality tools methodology. The proposed tools have been theoretically discussed and used to present the technical analysis of a mechanized mining support.

Findings: Two theoretical findings could be presented. Firstly this paper introduced the concept of a weighted Ishikawa diagram. Secondly it includes the concept of a stratification analysis a data classifier.

Research limitations/implications: The presented paper includes the description of possibilities of only one of many quality tools. The second limitation is considered with the analyzed technical mean, and namely a mining support. These limitations are the result of a range of the presented paper.

Practical implications: This paper shows the importance of integration the management and technical procedures. The application of proposed techniques allowed improving the construction of presented mining support.

Originality/value: The original ideas of the paper are: the concept of weighted Ishikawa diagram and the stratification analysis. These solution could be valuable for applications from the area of quality management and technical project management.

Keywords: Project management; Quality tools

1. Introduction

One of the quality tools applied in the area of quality management is the Ishikawa diagram [13]. This diagram includes relations between the specified causes and the investigated effect. Mostly the causes, in the Ishikawa diagram, are reduced to the group of six main factors: man, machine, material, method, management, measurement and environment [14]. Such a diagram is called the 6M+E type (Fig. 1).

The concept of a classical Ishikawa diagram is rather unilateral. It is impossible to obtain, using this diagram, the quantitative information of any form [15]. This limitation was the origin of investigations the weighted Ishikawa diagram. In this

concept the quantitative information is introduced to the diagram in the form of connections (fish bones) weights [16,17,19].

The methodology of the weighted Ishikawa diagram is presented below [9]:

- set of main causes determination,
- subcauses determination,
- weights of main causes determination,
- weighted Ishikawa diagram preparation,
- stratification analysis,
- the set of important causes and subcauses determination.

Basing on the stages, presented above, it is possible to prepare the weighted Ishikawa diagram. From the methodological point of view it is the complete tool of management. The connections weights could be determined using the specific form of a Saaty comparison matrix [7] what is presented in Fig. 2.

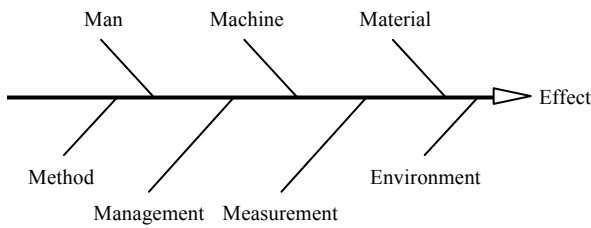

Fig. 1. The classical Ishikawa diagram [8]

	Man	Machine	Material	Method	Management	Measurement	Environment	Σ	Σ_n
Man	X	0,5	1	0,5	1	1	0,5	4,5	0,214
Machine	0,5	X	1	0,5	0,5	1	0	3,5	0,167
Material	0	0	X	0	0,5	0,5	0	1	0,048
Method	0,5	0,5	1	X	0,5	1	0,5	4	0,19
Management	0	0,5	0,5	0,5	X	1	0	2,5	0,119
Measurement	0	0	0,5	0	0	X	0	0,5	0,024
Environment	0,5	1	1	0,5	1	1	X	5	0,238

Fig. 2. The comparison matrix

The comparison matrix is a tool for comparing the causes of the same level of analysis using the specified scale of notes. In this work it has been applied the normalized, five-element set of notes: 0, 0.25, 0.5, 0.75 and 1. The note “0” means that the estimated element, in comparison with the other element is of no importance. The note “0.25” is for the elements of small importance. When the importance of two elements is equal it should be used the note “0.5”. The note 1 is for very important elements. Next the notes are summed (column Σ) and normalized (column Σ_n) to inscribe them to the Ishikawa weighted diagram.

The absolute weights of connections are computed by comparing the weights of subcases with the weights of main causes. It must be stated that for main causes the absolute and relative weights are equal. They differ only for subcases, what is presented on the exemplar weighted Ishikawa diagram (Fig. 3).

The weights in the weighted diagram could be classified according to their importance using the stratification analysis [7].

The classification rule bases on the histogram of weights and the form of its distribution function. The set of weights is divided on two subsets at the point of inflexion of the distribution curve (what is the main idea of so called the Pareto rule). The exemplar set of causes (Fig. 4) has been divided on 7-elements important subset and 12-elements less important one.

In this way it is possible to obtain the quantitative information using the Ishikawa diagram. In the presented example one can find out that the weights for causes called: environment 1 and 2, machine 1, man 2 and 3, method 1 and 2 generate over 70% of all causes of the analyzed effect (cumulated weight).

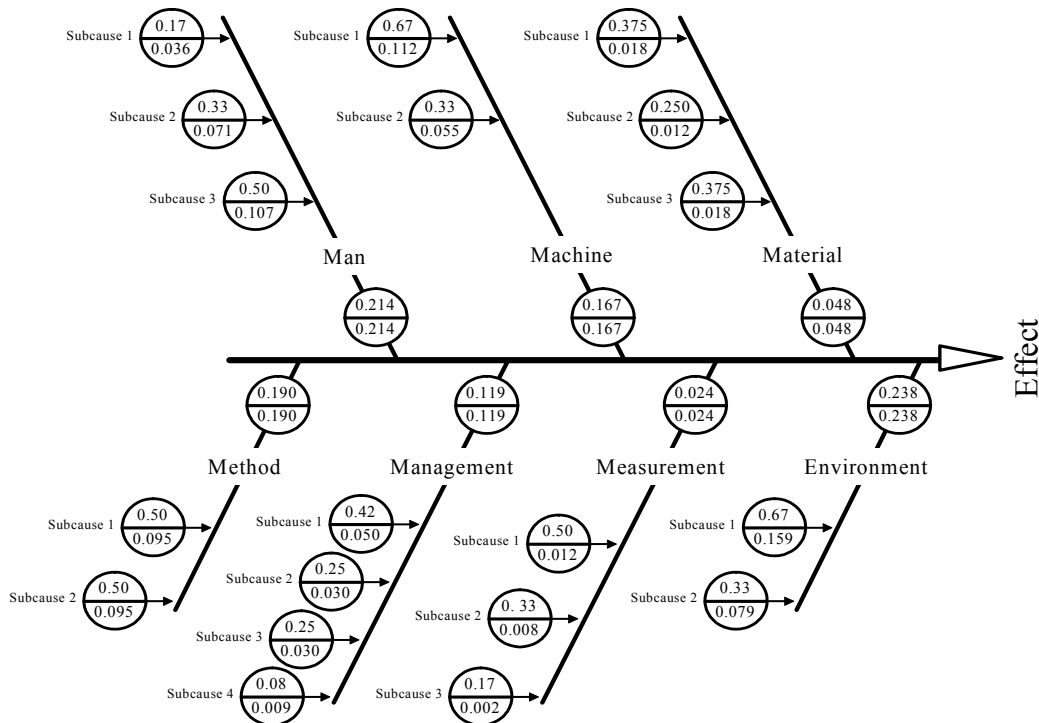

Fig. 3. The concept of the weighted Ishikawa diagram

No	Subcause	Weight	Cumulate weight	Reference index
1	environment 1	0.159	0.159	2.862
2	machine 1	0.112	0.271	4.607
3	man 3	0.107	0.378	6.048
4	method 1	0.095	0.473	7.095
5	method 2	0.095	0.568	7.952
6	environment 2	0.079	0.647	8.411
7	man 2	0.071	0.718	8.616
8	machine 2	0.055	0.773	8.503
9	management 1	0.050	0.823	8.230
10	man 1	0.036	0.859	7.731
11	management 2	0.030	0.889	7.112
12	management 3	0.030	0.919	6.433
13	material 1	0.018	0.937	5.622
14	material 3	0.018	0.955	4.775
15	material 2	0.012	0.967	3.868
16	measurement 1	0.012	0.979	2.937
17	management 4	0.009	0.988	1.976
18	measurement 2	0.008	0.996	0.996
19	measurement 3	0.002	0.998	0

Fig. 4. The stratification analysis

2. The application of the diagram

The complete tool, which is the weighted Ishikawa diagram, could be utilized in different areas of management, not only in the area of quality management. The main advantage of this tool is its simplicity, so it could be used by different managers. It is still a good tool for quality circles. The second advantage is the possibility for determining the values of weights. It is consider with the fact that people could better understand the importance of each cause when it is presented in a numerical form. It allows also avoiding long discussions about the importance of causes.

This tool could be utilized for different engineering problems [3]. The paper presents the application of the diagram for improving of the construction of a mining support (Fig. 5). The analysis of the support based on the interviews with miners (users of that machine), maintenance engineers and designers. The aim of the interviews was to obtain the information about different causes of faults and to evaluate them. Basing on the results of these investigations it has been prepared the proposal of changing some constructional joints of a classical support. The process is summarized below.

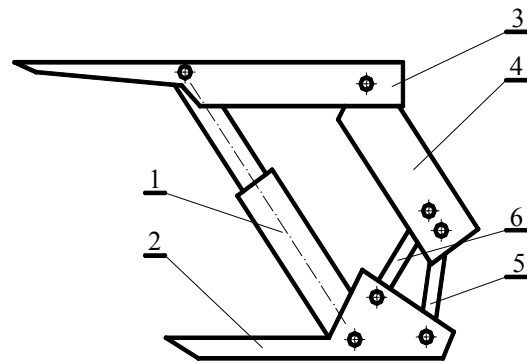

Fig. 5. The scheme of a traditional mining support [1]: 1- hydraulic cylinders, 2- foot piece, 3- roof bar, 4- shield, 5- rear lemniscate link, 6- front lemniscate link

3. Faults according to the 6M+E model

Interviews allow pointing the causes of main faults of a traditional mining support. The weights of the main causes, according to the 6M+E model, are presented in the Fig. 6. The comparison matrix shows that the main problems are considered with the next groups of causes: machine, environment and man. It means that main problems with the support are considered with human mistakes and geological conditions. They generate 64% of total causes. The other causes are of less importance.

The described causes are presented as an Ishikawa diagram in Fig. 7. On this diagram the relative and absolute weights are included. The mentioned three groups of main causes include 64% of the total number of general faults. So one can easily state that solving problems consider with these groups could radically improve the work of a suport.

	Man	Machine	Material	Method	Management	Measurement	Environment	Σ	Σ_n
Man	X	0.25	0.75	0.75	0.75	1	0.5	4	0.19
Machine	0.75	X	1	1	0.75	1	0.5	5	0.24
Material	0.25	0	X	0.25	0.25	0.5	0	1.25	0.06
Method	0.25	0	0.75	X	0.75	0.75	0.25	2.75	0.13
Management	0.25	0.25	0.75	0.25	X	0.75	0.25	2.5	0.12
Measurement	0	0	0.5	0.25	0.25	X	0	1	0.05
Environment	0.5	0.5	1	0.75	0.75	1	X	4.5	0.21

Fig. 6. The comparison matrix of main faults of a mining support

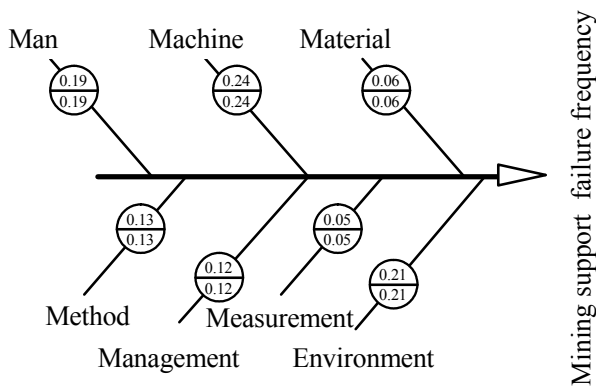

Fig. 7. The general weighted Ishikawa diagram for the construction defects of the support

The next step was to determine the particular faults. They are described below in a sequence of importance.

3.1. Faults from the machine group

The researches and interview let gather next subcause which are consider to be important from the point of view of engineers. This group of subcauses includes:

- skew hydraulic cylinder,
- one pair of hydraulic cylinders,
- head shield,
- head shield mounting,
- too long roof bar,
- not safety work place,
- not protected against dynamic load,
- too large support mass,
- wrong safety parametr,
- wrong sets of joint.

The presented subcauses in different way affect the work of a mining support. The first problem is considered with skew hydraulic cylinder [11]. Their placing results in transformation the roof force into two component forces (Fig.8).

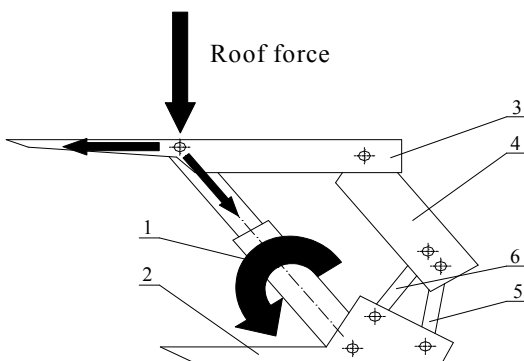

Fig. 8. The scheme of forces in a support system

One, the skew is positive and is balanced with the force of a hydraulic cylinder. The second (horizontal) is harmful because it generates the additional stresses in a support system. It causes that the mass of a support must be larger to withdraw such loads.

The second problem is considered with the application of two cylinders. Firstly when only two cylinders are used (apart from four) they must be larger and heavier to generate the same support force. Consequently other support element should be larger because each of two cylinders generates the force which is two times larger. Secondly in such constructional system there is no place for workers. They must work in the front of the support and they are not protected against the fall of stones from a wall. When four cylinders support is used workers work protected by the first row of cylinders. Also they have a safety passage between the first and the second row of cylinders.

The next problem is considered with the head shield construction. It is mounted on the front edge of a roof bar. It should protect the work place under a support against a fall of stones and coal from the wall. Unfortunately it is often broken by a mechanical miner which mines too high. So it is needed to design the head shield in a way that it would be not possible to for a miner to reach the shield. One must say that this problem is also pointed by the repair teams. The main cause of this problem is considered with support operators who forget to close a shield. The other cause is described below.

With head shields is related also the problem of their mounting systems. Some shields are mounted using a comb joint. In mine conditions such joint often blocks.

To eliminate this problem (related with the construction of a head shield) it was proposed a mining support with longer roof bar. However researches show that such support is unstable. It is dangerous when a tremor occurs.

Next problems are considered with dynamic loads. The construction of a support is very rigid and not prepared for dynamic forces of tremors. Now the dynamic loads cause cylinders bursting. It is reported in many cases. It is the result of short times of load increasing.

To reduce the influence of dynamic load designers elaborated more powerful support systems. It results in a larger support mass. And a heavy support generates transport problems and mounting problems. One should point that these operations are conducted in mine walls.

It is also important to point out that some problems consider with mining support exploitation is related with design parameters. For example the construction could be less strength when designers use too low safety index. Normally for dynamic loads is used an index equal to 1.5. Analyzing results of tremors one should state that such designed supports do not resist the dynamic loads. Moreover it is stated that in case of larger tremors they normally are broken.

All the causes, mentioned above, result in large stresses in the area of joints. So they wear in quick pace. It generates a lot of repairing problems.

The presented causes are compared using the comparison matrix (Fig. 9). Also they are presented in a graphical form as an Ishikawa diagram (Fig. 10). One can see that two main causes of failure frequency are: skew cylinder and two cylinders. They generate, according gathered data, 38.6% of failures.

	Skew cylinders	Two cylinders	Head shield	Head shield mounting	Long roof bar	Safety work place	Dynamic load	Large mass	Safety index	Joints construction	Σ	Σ_n
Skew cylinders	X	0.5	1	1	1	1	1	1	1	1	8.5	0.193
Two cylinders	0.5	X	1	1	1	1	1	1	1	1	8.5	0.193
Head shield	0	0	X	1	1	0	0	0	0	0.5	2.5	0.057
Head shield mounting	0	0	0	X	0	0	0	0	0	0.5	0.5	0.011
Long roof bar	0	0	0	1	X	0	0	0.5	0	0.5	1	0.023
Safety work place	0	0	1	1	1	X	0.5	1	0	1	5.5	0.125
Dynamic load	0	0	1	1	1	0.5	X	1	0.5	1	6	0.136
Large mass	0	0	1	1	0.5	0	0	X	0	1	3.5	0.080
Safety index	0	0	1	1	1	1	0.5	1	X	1	6.5	0.148
Joints construction	0	0	0.5	0.5	0.5	0	0	0	0	X	1.5	0.034

Fig. 9. Comparison matrix for faults from the MACHINE group

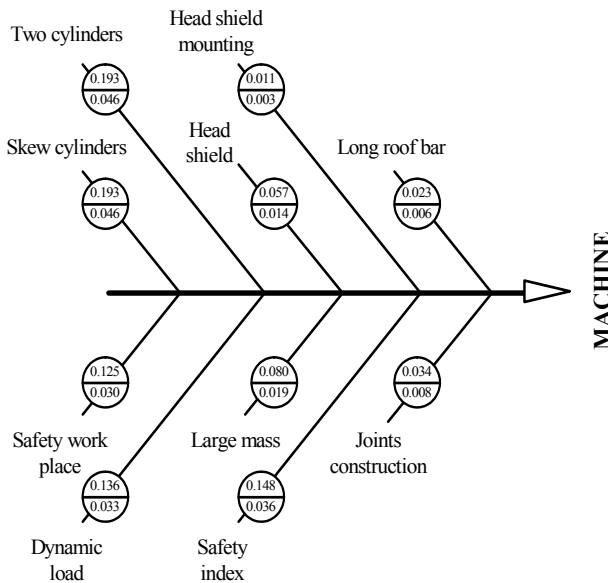

Fig. 10. The weighted Ishikawa diagram for faults from the MACHINE group

3.2. Faults from the environment group

In this group are gathered the causes consider with mining and geological conditions. They could be called as natural causes. This group includes (Fig. 11):

- bumps,
- rock shocks,
- rock slides,
- roof loads,
- corrosion environment.

The most important cause of this group is related with bumps. A bump is a violent phenomenon of releasing a huge elastic energy accumulated in a rock mass [1]. A support must transform the bump energy into its work. To make such transformation the support construction should be flexible. Unfortunately the present support constructions are designed as rigid.

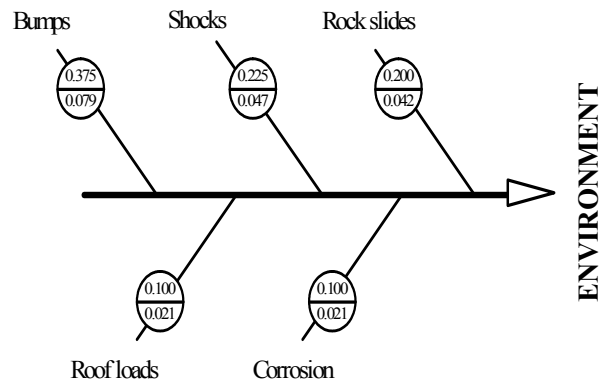

Fig. 11. The weighted Ishikawa diagram for faults from the ENVIRONMENT group

The second cause is called shocks. Shocks could be described as moves in a lithosphere resulted from tectonic forces or mining works [3]. Shocks occur very often but they are not so powerful like bumps. They are the cause of fatigue loading the support.

Rock slides are defined as the rock fall causing the choking of a working heading [1]. Rock slides are particularly dangerous for worker working near the support. Properly designed support should cover the working place.

The next subcause is called roof loads. They could be described as a roof pressure. This state is resulted from the weight of overlaying beds being of natural or exploitation origin [1]. The roof loads could be treated as static load of a support. They act continuously in the direction compatible with the direction of overlaying beds. It causes the quick wear of constructional nodes of a support.

The last subgroup is considered with the corrosion processes. In mines they are more intensive as mining water includes lots of salt compounds. Secondly all mining machines must work in a moisture enrolment.

As one can see in the Fig.11 the most important causes of his group are: bumps and shocks. They generate 60% effects generated by causes of this group.

3.3. Faults from the man group

According to interviews the main causes generated by a human factor could be described as below:

- incidental support withdrawing,
- head shield damaging,
- walking on a conveyor,
- section shifter break,
- bad mounting of equipment.

These subcauses are presented in the Fig. 12 in a form of an Ishikawa matrix.

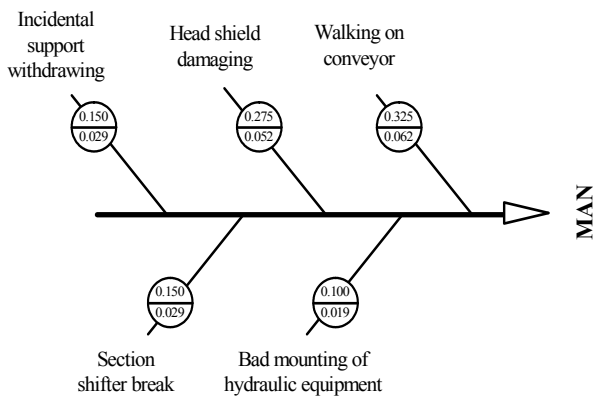

Fig. 12. The weighted Ishikawa diagram for faults from the MAN group

The first subcause presents a case in which operator withdrawn a support when workers are still under this support. It causes serious hurts and even death of workers. This accident is considered with a hurry in work. Fortunately they are very rare.

The next subcause is also considered with a hurry in work. Work procedures point out that a head shield should be hidden by the operator before the coal planner move by. But operators often forget to do that. The third cause is considered with the lack of safe working place in the area of a support. The classical support has no safety passage for miners. According to procedures miner should walk under the front part of a roof bar. But often in this place is mounted a conveyor. So miners often walk along the conveyor.

The other causes of this group are of less importance. From this group the most important are: the second and third subcauses. They generate about 60% of reported problems.

3.4. Faults from the material group

The next group includes problems consider with a material used in a support construction. Generally this group consists of problems that are generated by the suppliers of mining equipment plants. In this group one can point three main causes (Fig.13).

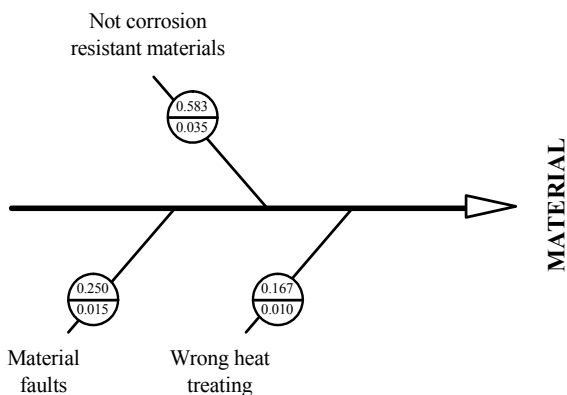

Fig. 13. The weighted Ishikawa diagram for faults from the MATERIAL group

From these three causes the most important (58%) is the problem considered with non corrosion materials [2, 20].

3.5. Faults from the measurement group

Below is presented the diagram for causes from the group of measurement problems (Fig. 14).

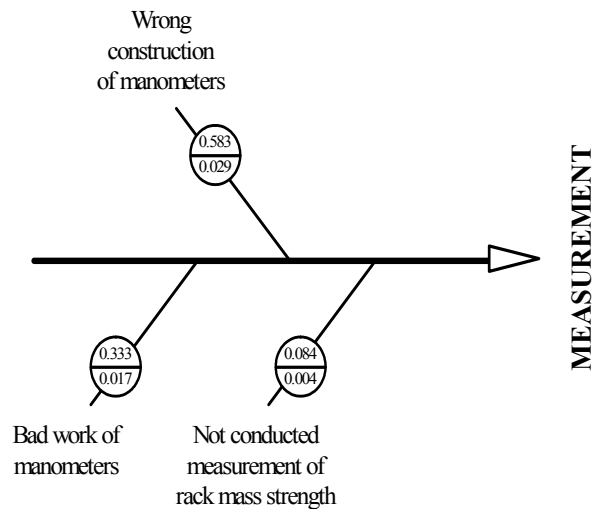

Fig. 14. The weighted Ishikawa diagram for faults from the MEASUREMENT group

3.6. Faults from the method group

The Figure 15 presents one general cause considered with applied mining method.

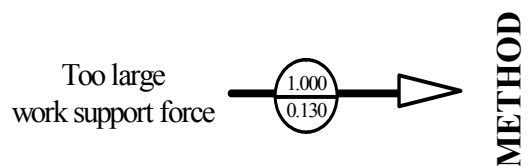

Fig. 15. The weighted Ishikawa diagram for faults from the MATERIAL group

3.7. Faults from the management group

Figure 16 presents causes from the group called Management.

This group includes problem that are frequently reported from management literature. The bureaucracy of mining industry is often called a mock one. It means that managers often hide the causes of many accidents. It is stated that they treat the work inspection like work problems and not means to improve work conditions.

4. General faults analysis

In the Figure 17 is presented the general Ishikawa diagram. It links all the mentioned subgroups of problems resulting in a higher failure frequency. Comparing the absolute weights of subcauses one can show the group of the most important problems pointed in the project preparing stage.

The group of the most important problems includes next causes:

- too large work support forces (13%),
- bumps (8%),
- walking along the conveyor (6%),
- bad training system (6%),
- papering over accident causes (6%),
- head shield damaging (5%).

These problems generate 44% of failure cause. The aim of the designer group should be consider with eliminations the problem described above. Moreover it is important to state that these problems belong to different groups so heir elimination must be a complex process.

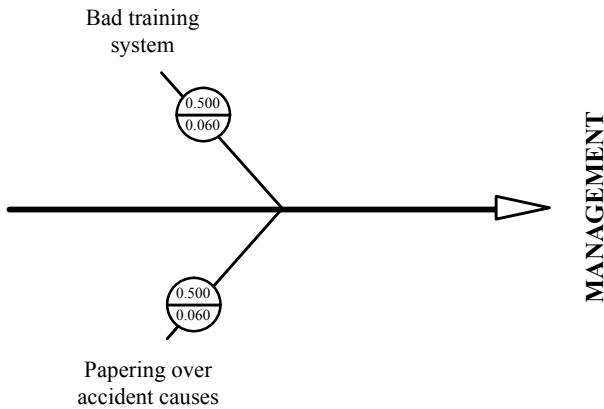

Fig. 16. The weighted Ishikawa diagram for faults from the MANAGEMENT group

Secondly the training system in mines is not proper. In some cases workers take part in trainings that are not consider with their work place. It is only checked the number of courses and their time.

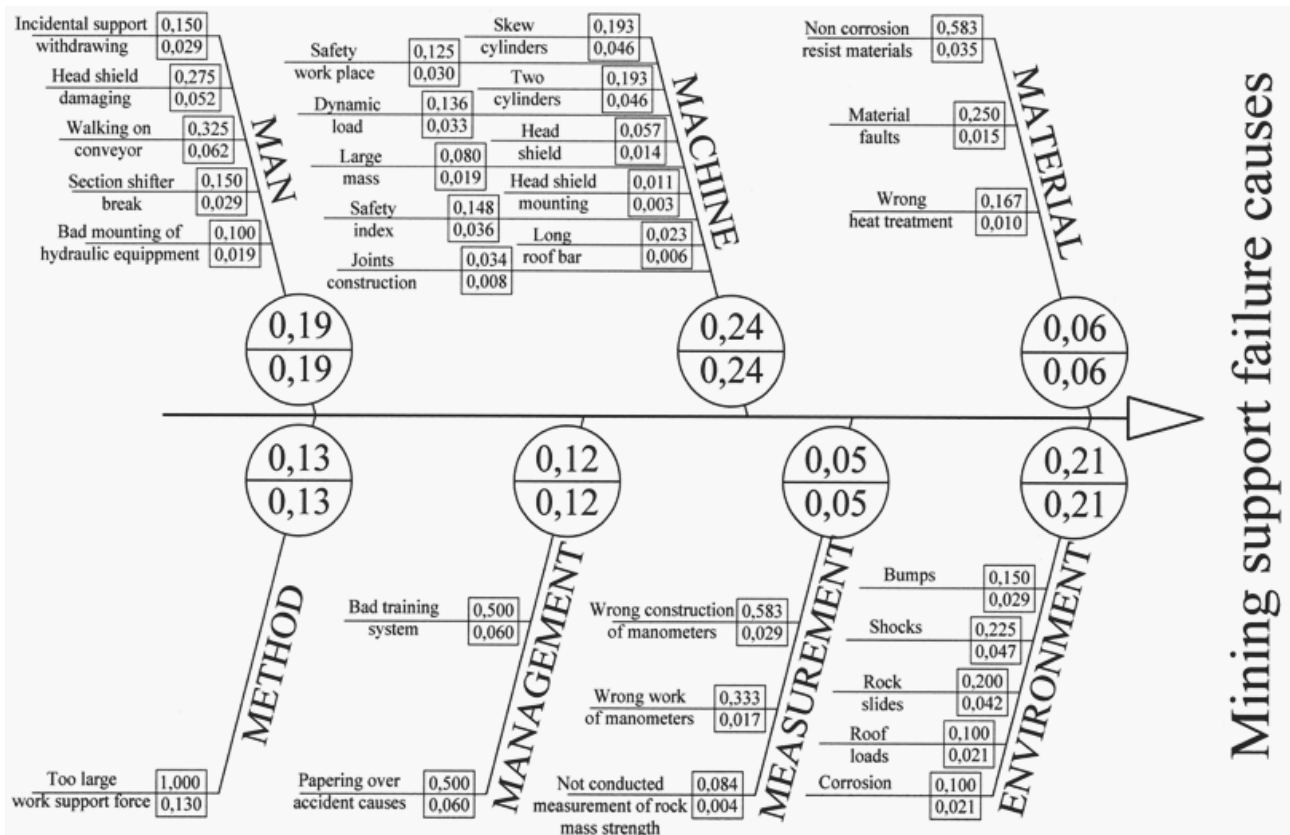

Fig. 17. General weighted Ishikawa diagram for a mining support

5. Conclusions

The results of investigations allow preparing propositions for designing a new mining support (Fig. 18). It is important to state that his prototypic support has been manufactured using recycled parts. Cylinders 2, 3, roof bars 5 and foot pieces 1 are utilized from old supports. It allows decreasing the cost structure of a new product to 50% [6,18].

The main visible change in the construction of the new mining support is considered with its support system. It has been applied four vertical hydraulic cylinders. So the acting load forces influence the cylinders axially.

To protect cylinders against dynamic loads the pneumatic accumulators 9 have been used. The straight-line mechanism 4 limits the moves of the roof bar 5.

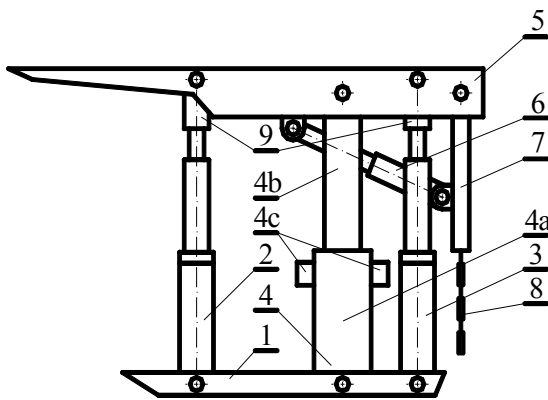

Fig. 18. Proposition of new construction of a support

Also it was important for the designers of the new support to take into considerations the problems of human factors. The application of four cylinders allows planning the passage for workers between them. So the miners are protected by these cylinders. It is important to state that some solutions are protected by Polish Patent [12].

It is important to mark that the presented method also includes elements of technical data acquisition [4] and technical project management [5]. It proves too the universality of the presented approach of the technical project management [10].

References

- [1] Collaborative work, Mining Lexicon, Śląsk Press, Katowice, 1989 (in Polish).
- [2] A. Balitskii, Physical Metallurgy of Extra Strength Nitrogen Stainless Steel, Materials Engineering 4 (2001) 193-196.
- [3] M. Bobrek, V. Majstorovic, M. Sokovic, Design Approach in Management toward to Business Excellence, Journal of Achievements in Materials and Manufacturing Engineering 16 (2006) 184-189.
- [4] S. Burke, W. Gaughran, A. Ryan, Sustainability/product life-cycle management, Proceedings of the 13th International Scientific Conference "Achievements in Mechanical and Materials Engineering" AMME'2005, Gliwice-Wisła, 2005, 55-58.
- [5] F. Cus, M. Milfelner, J. Balic, An overview of data acquisition system for cutting force measuring and optimization in milling, Proceedings of the 13th International Scientific Conference "Achievements in Mechanical and Materials Engineering" AMME'2005, Gliwice-Wisła, 2005, 79-82.
- [6] C. Grabowik, Z. Monica, I. Wosik, G. Ćwikła, A. Gwiazda, The Cost Estimation during The design Phase Using CAX Methods, Proceedings of the 13th International Scientific Conference "Achievements in Mechanical and Materials Engineering" AMME'2005, Gliwice-Wisła, 2005, 751-760.
- [7] A. Gwiazda, The Method of Information Ordering Using the Pareto Rule, Economics and Production Organization 11 (2002) 21-28 (in Polish).
- [8] A. Gwiazda, The Analysis of Ishikawa Diagrams Models, Economics and Organization 12 (2005) 59-66 (in Polish).
- [9] A. Gwiazda, The Concept of Weighted Ishikawa Diagram, Quality Problems 4 (2005) 13-17 (in Polish).
- [10] A. Gwiazda, Quality Tools in a Process of Technical Project Management, Journal of Achievements in Materials and Manufacturing Engineering 18 (2006) 439-442.
- [11] J. Gwiazda, Mining Support Resistant against Bumps, Śląsk Press, Katowice, 1998 (in Polish).
- [12] J. Gwiazda, A.Gwiazda, Mechanized Strait-line Support, Polish Patent No. 166872, 1995 (in Polish).
- [13] K. Ishikawa, Guide to Quality Control, Asian Productivity Organisation, Tokyo, 1976.
- [14] M. Jedliński, Quality in Modern Management, Business West-Pomeranian School Press, Szczecin, 2000 (in Polish).
- [15] E. Kindlarski, Products Quality, PWN, Warsaw, 1988 (in Polish).
- [16] E. Krodkiewska-Skoczylas, Methods and Tools of Quality Improvement, The Publishing of the Club of Polish ISO-9000 Forum, Warsaw, 2000 (in Polish).
- [17] E. Malinowska, W. Nierzwicki, M. Richert, M. Wiśniewska, Quality Management. Chosen Problems, The Center for Human Resources Improvement, Gdańsk, 1999 (in Polish).
- [18] J. Michalska, Quality Costs in the Production Process, Journal of Achievements in Materials and Manufacturing Engineering 17 (2006) 425-429.
- [19] J. Oakland, Total Quality Management, Oxford Press, Oxford, 1994.
- [20] S. Topolska, Characteristic Defects of Metallic Coatings Obtained in the Metallization Process, Proceedings of the 13th International Scientific Conference "Achievements in Mechanical and Materials Engineering" AMME'2005, Gliwice-Wisła, 2005, 675-680.