

Fabrication of bulk metallic glasses by centrifugal casting method

R. Nowosielski, R. Babilas*

Division of Nanocrystalline and Functional Materials and Sustainable Pro-ecological Technologies, Institute of Engineering Materials and Biomaterials, Silesian University of Technology, ul. Konarskiego 18a, 44-100 Gliwice, Poland

* Corresponding author: E-mail address: rafal.babilas@polsl.pl

Received 16.10.2006; accepted in revised form 15.11.2006

Manufacturing and processing

ABSTRACT

Purpose: The aim of the present work is characterization of the centrifugal casting method, apparatus and produced amorphous materials, which are also known as bulk metallic glasses

Design/methodology/approach: The studied centrifugal casting system consists of two main parts: casting apparatus and injection system of molten alloy. The described centrifugal casting method was presented by preparing a casting apparatus "CentriCast – 5". The apparatus includes a cylindrical copper mold, which is rotated by a motor. The transmission allows to changing the speed of rotating mold.

Findings: Bulk metallic glasses are a novel class of engineering materials, which exhibit excellent mechanical, thermal, magnetic and corrosion properties. Centrifugal casting is a useful method to produce bulk amorphous materials in form of rings, tubes or cylindrical parts. Presented centrifugal casting method and casting apparatus has been prepared to fabricate the samples of bulk metallic glass in form of rings with an outer diameter of 25 mm and controlled thicknesses by changing the weight of the molten alloy.

Research limitations/implications: Studied centrifugal casting method and casting apparatus has been prepared to fabricate the samples of bulk metallic glass. For future research a characterization of microstructure and properties of prepared material will be performed.

Practical implications: The centrifugal casting is a useful process to produce bulk amorphous materials in form of rings, tubes or graded amorphous matrix composites. It seems to be a very simple method, which allows to obtain BMG materials.

Originality/value: The centrifugal casting method allows to produce bulk amorphous rings with thickness above 1-mm.

Keywords: Casting, Amorphous materials; Bulk metallic glasses; Centrifugal casting

1. Introduction

The discovery of bulk metallic glasses (BMGs) has caused new interest in research on glassy metals. Before the development of BMG materials there have been many limitations of using metallic glasses, mainly limitation of size and workability [1-5]. The problem of size and forming has been solved by discovery of bulk metallic glasses, which have a wide supercooled liquid region and high glass-forming ability [6-8].

Bulk metallic glasses are a novel class of engineering materials, which have unique mechanical, thermal, magnetic and corrosion properties. That properties are attractive compared with conventional crystalline alloys and are very useful in wide range of engineering applications [9].

A variety of rapid solidification techniques are used to obtain BMG materials. Although large amount of bulk amorphous materials can be fabricated directly by casting of the molten alloy into a bulk form or consolidation of the powders of glassy metals [10]. Series of bulk metallic glasses, which has been produced by

casting methods includes alloy systems based on Pd, Zr, Ti, Ni, Cu, Co, Fe, Mg with a critical cooling rate less than 10^3 K/s and thickness above 1 mm [11]. Formation of BMG materials depends of many internal factors such as purities and atomic size of the constituent elements or external factors such as cooling rate [12].

2. Description of materials

Since the first synthesis of Au-Si amorphous alloy system by a rapid solidification technique in 1960 (Fig.1), a number of studies have been carried out on the formation of the metallic glasses. The most alloys exhibit low glass-forming ability (GFA) and high critical cooling rates were required to form metallic glasses before 1988 [13].

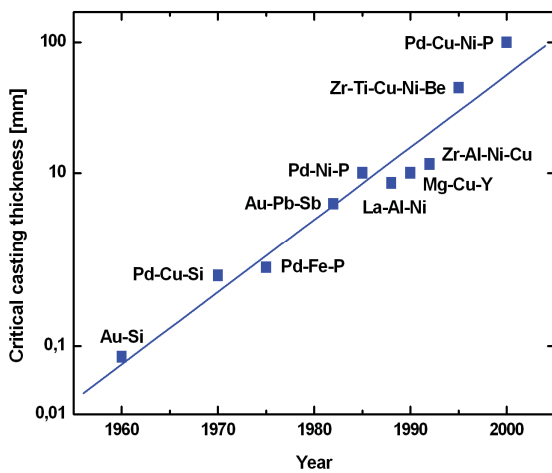

Fig.1. The critical casting thickness of chosen bulk metallic glasses as a function of their discovering year [14]

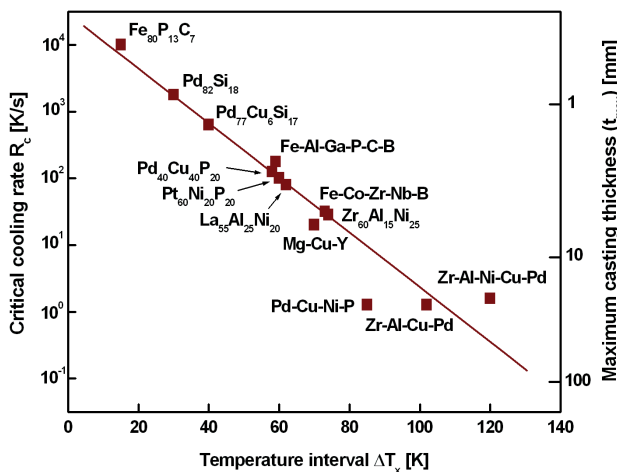

Fig. 2. Relations between critical cooling rate (R_c), maximum casting thickness (t_{max}) and temperature interval (ΔT_x) between crystallisation temperature (T_x) and glass transition temperature (T_g) for various bulk metallic alloys [15,16]

Since 1990s, a number of glass-forming systems with excellent GFA in the Mg-, Ln-, Zr-, Fe-, Pd-, Ti- and Ni- have been found successfully, which enable the preparation of bulk specimens with dimensions in the millimeter-range by conventional metallurgical casting methods [15].

The glass-forming ability of bulk metallic alloys depends on temperature difference (ΔT_x) between glass transition temperature (T_g) and crystallisation temperature (T_x). The increase of ΔT_x causes the decrease of critical cooling rate (R_c) and growth of maximum casting thickness of bulk metallic glasses, especially in Zr-Al-Ni-Cu or Pd-Cu-Ni-P alloy systems (Fig.2) [17].

Table 1. Typical nonferrous and ferrous bulk metallic alloys with year of their developed [16]

Nonferrous alloy systems		
1.	Ln-Al-TM (Ln - lanthanide metal)	1989
2.	Zr-Al-TM (TM - group transition metal)	1990
3.	Zr-Nb-Al-TM	1990
4.	Ti-Zr-TM	1993
5.	Zr-(Ti,Pd)-Al-TM	1995
6.	Pd-Ni-Fe-P	1996
7.	Pd-Cu-B-Si	1997
8.	Ti-Ni-Cu-Sn	1998
Ferrous alloy systems (Fe-,Co-,Ni-bases)		
9.	Fe-(Nb,Mo)-(Al,Ga)-(P,B,Si)	1995
10.	Co-(Al,Ga)-(P,B,Si)	1996
11.	Fe-(Zr,Hf,Nb)-B	1996
12.	Co-Fe-(Zr,Hf,Nb)-B	1996
13.	Ni-(Zr,Hf,Nb)-(Cr,Mo)-B	1996
14.	Fe-Co-Ln-B	1998
15.	Fe-(Nb,Cr,Mo)-(P,C,B)	1999
16.	Ni-(Nb,Cr,Mo)-(P,C,B)	1999

The bulk amorphous alloy systems can be divided into nonferrous and ferrous types. It is important that bulk amorphous alloys can be fabricated in specified engineering alloy systems such as Fe-, Co-, Ni-, Mg-, Ti- and Zr-bases. The maximum diameter of the bulk amorphous alloys tends to increase in the order of Pd-Cu > Zr > Ln = Mg > Fe > Ni > Co = Ti systems. Table 1 presents the bulk amorphous alloy systems reported up to date with the years, when each alloy system was reported [18].

Unique properties of bulk metallic glasses causes that this materials are adopted for applications in many fields and they will be more significant engineering materials in the future (Tab.2).

Table 2. Main properties and application of bulk metallic glasses [17]

No.	Properties	Application
1.	High strength	Machinery materials
2.	High hardness	Optical precision materials
3.	High fracture toughness	Die materials
4.	High impact fracture energy	Tool materials
5.	High fatigue strength	Cutting materials
6.	High corrosion resistance	Corrosion resistant materials
7.	High wear resistance	Hydrogen storage materials
8.	High reflection ratio	Composite materials
9.	Good soft magnetism	Writing appliance materials
10.	High magnetostriction	Bonding materials

Many methods for fabrication of bulk amorphous alloy have been developed, such as copper mold casting, die casting, suction-casting, tilt casting, rotating disk casting and mold-clamp casting. Basing on mention methods the paper presents the centrifugal casting system to produce bulk amorphous rings [19,20].

3. Description of method and setup

The studied centrifugal casting system consists of two main parts: casting apparatus and injection system of molten alloy. The casting apparatus includes a cylindrical copper mold, which is rotated by a motor with a belt transmission. The transmission allows to changing the speed of rotating mold. Moreover, the injection system consists of quartz container, where the alloy ingot is melted by inducing melting. Process of ingot melting is realized by using high frequency power supply.

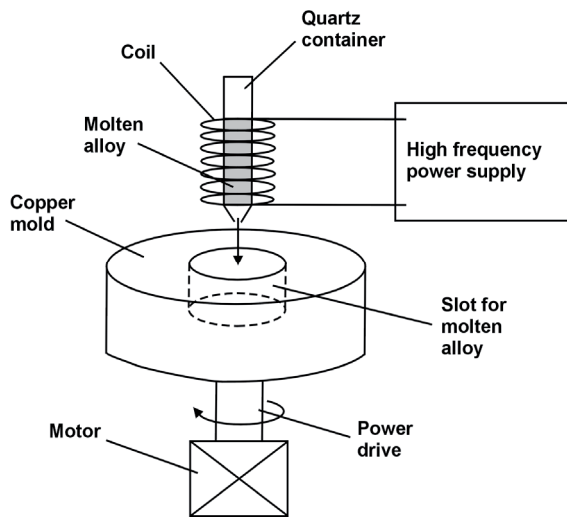

Fig. 3. Schematic diagram of the centrifugal casting setup with injection system of molten alloy

Figure 3 shows a schematic illustration of the centrifugal casting method with injection system of molten alloy used for the production of bulk amorphous rings. Schematic illustration of the centrifugal casting apparatus is presented in Figure 4.

Described method allows to fabricate bulk amorphous materials in form of ring with diameter of 25 mm. The ingot which is put in quartz nozzle is melted by induction melting in an argon atmosphere and then the molten alloy is injected into a cylindrical copper mold, which is rotating with speed of 2500, 3000 or 3500 rpm. The thickness of the ring could be controlled by changing the weight of the molten alloy.

The copper mold has the outer diameter of 150 mm, the inner diameter of 25 mm and the thickness of 50 mm. The solidification process of liquid alloy depends on many parameters such as time, metal density, thermal conductivity, cooling rate, melting temperature. Mention elements decide of forming of amorphous structure in casted materials.

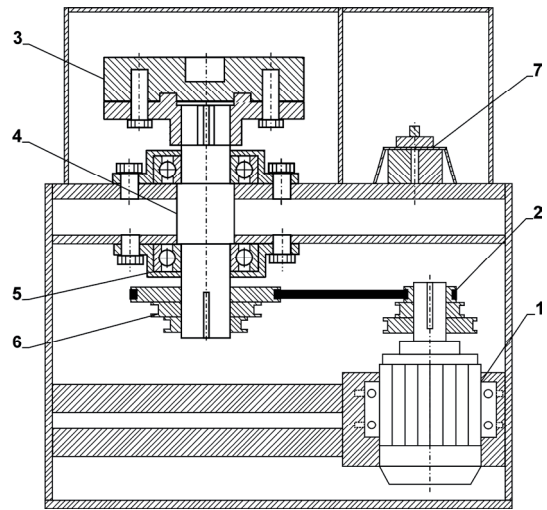

Fig. 4. Schematic illustration of the centrifugal casting apparatus: (1 – motor, 2 – belt transmission, 3 – copper mold, 4 – shaft, 5 – bearing, 6 – belt pulley, 7 – breaker switch)

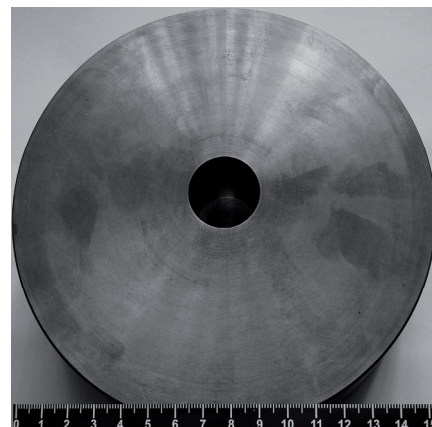

Fig. 5. The cylindrical copper mold with slot for molten alloy

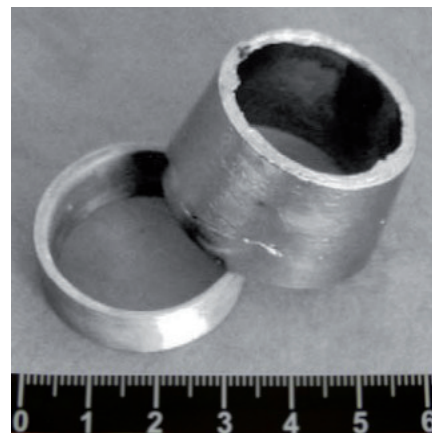

Fig. 6. Samples of bulk metallic glasses in a ring form fabricated by centrifugal casting method [19]

Figure 6 shows the surface appearance of two exemplary rings of $Zr_{55}Al_{10}Ni_5Cu_{30}$ alloy with an outer diameter of 25 mm and 1 mm in thicknesses. Moreover, the cylindrical copper mold for casting shown rings is presented in Figure 5.

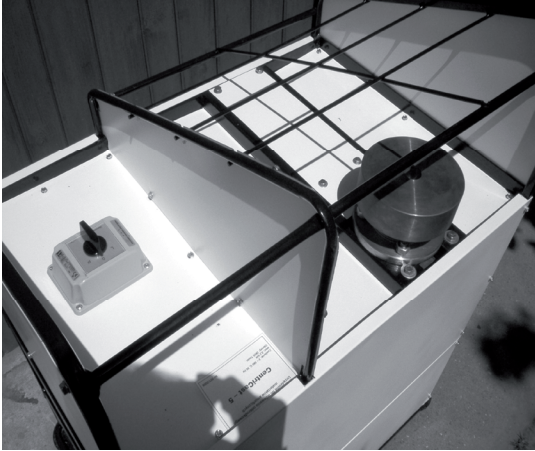

Fig. 7. Photograph of the centrifugal casting apparatus ("CentriCast - 5") - top view

The studied machine are equipped in electric motor, which is worked on voltage of 380 V and frequency of 50 Hz. Power of engine is 2.2 kW. The rotation speed of cylindrical mold could be changed by belt transmission in rotation range from 2500 to 3500 1/min. Photographs of the centrifugal casting apparatus are shown in Figure 7.

4. Conclusions

The descriptions of the presented bulk metallic glasses and prepared centrifugal casting apparatus allowed to formulate the following statements:

- bulk metallic glasses are a novel class of engineering materials, which exhibit unique mechanical, thermal, magnetic and corrosion properties;
- the centrifugal casting is a useful method to produce bulk amorphous materials in form of rings, tubes or graded amorphous matrix composites;
- presented centrifugal casting method and casting apparatus "CentriCast - 5" has been prepared to fabricate the samples of bulk metallic glass in form of rings, with an outer diameter of 25 mm;
- the studied centrifugal casting system consists of two main segments: casting apparatus and injection system of molten alloy.

References

- [1] R. Nowosielski, J.J. Wysocki, I. Wnuk, P. Sakiewicz, P. Gramatyka, Ferromagnetic properties of polymer nanocomposites containing $Fe_{78}Si_9B_{13}$ powder particles, *Journal of Materials Processing Technology* 162-163 (2005) 242-247.
- [2] R. Nowosielski, J.J. Wysocki, I. Wnuk, P. Gramatyka, Nanocrystalline soft magnetic composite cores, *Journal of Materials Processing Technology* 175 (2006) 324-329.
- [3] R. Nowosielski, L.A. Dobrzański, P. Gramatyka, S. Griner, J. Konieczny, Magnetic properties of high-energy milled $Fe_{78}Si_{13}B_9$ nanocrystalline powders and powder-based nanocomposites, *Journal of Materials Processing Technology* 157-158 (2004) 755-760.
- [4] S. Lesz, R. Szewczyk, D. Szewieczek, A. Bieńkowski, The structure and magnetoelastic properties of the Fe-based amorphous alloy with Hf addition, *Journal of Materials Processing Technology* 157-158 (2004) 743-748.
- [5] Y. Kawamura, Liquid phase and supercooled liquid phase welding of bulk metallic glasses, *Materials Science and Engineering A* 375-377 (2004) 112-119.
- [6] M. Bakal, A.J. Shih, R.O. Scattergood, Chip formation, cutting forces, and tool wear in turning of Zr-based bulk metallic glass, *International Journal of Machine Tools & Manufacture* 44 (2004) 915-925.
- [7] M. Heilmaier, Deformation behaviour Zr-based metallic glasses, *Journal of Materials Processing Technology* 117 (2001) 374-380.
- [8] Y. Saotome, S. Miwa, T. Zhang, The micro-formability of Zr-based amorphous alloys in the supercooled liquid state and their application to micro-dies, *Journal of Materials Processing Technology* 113 (2001) 64-69.
- [9] C.H. Wong, Friction welding of $Zr_{41}Ti_{14}Cu_{12.5}Ni_{10}Be_{22.5}$ bulk metallic glass, *Scripta Materialia* 49 (2003) 393-397.
- [10] T. Shoji, Y. Kawamura, Y. Ohno, Friction welding of bulk metallic glasses to different ones, *Materials Science and Engineering A* 375-377 (2004) 394-398.
- [11] S. Li, D.Q. Zhao, M.X. Pan, W.H. Wang, A bulk metallic glass based on heavy rare earth gadolinium, *Journal of Non-Crystalline Solids* 351 (2005) 2568-2571.
- [12] W.H. Wang, Z. Bian, P. Wena, Y. Zhanga, M.X. Pana, Role of addition in formation and properties of Zr-based bulk metallic glasses, *Intermetallics* 10 (2002) 1249-1257.
- [13] J. Zhang, Y.H. Wei, K.Q. Qiu, H.F. Zhang, M.X. Quan, Z.Q. Hu, Crystallization kinetics and pressure effect on crystallization of $Zr_{55}Al_{10}Ni_5Cu_{30}$ bulk metallic glass, *Materials Science and Engineering A357* (2003) 386-391.
- [14] J.F. Loeffler, Bulk metallic glasses, *Intermetallics* 11 (2003), 529-540.
- [15] J. Basu, S. Ranganathan, Bulk metallic glasses: A new class of engineering materials, *Sadhana* 28 (2003) 783-798.
- [16] A. Inoue, Bulk amorphous and nanocrystalline alloys with high functional properties, *Materials Science and Engineering A304-306* (2001) 1-10.
- [17] W.H. Wang, C. Dong, C.H. Shek, Bulk metallic glasses, *Materials Science and Engineering R* 44 (2004) 45-89.
- [18] M. Telford, The case for bulk metallic glass, *Materialstoday*, March 2004 (2004) 36-43.
- [19] Q.S. Zhang, D.Y. Guo, A.M. Wang, H.F. Zhang, B.Z. Ding, Z.Q. Hu, Preparation of bulk $Zr_{55}Al_{10}Ni_5Cu_{30}$ metallic glass ring by centrifugal casting method, *Intermetallics* 10 (2002) 1197-1201.
- [20] J.W. Gao, C.Y. Wang, Modeling the solidification of functionally graded materials by centrifugal casting, *Materials Science and Engineering A292* (2000) 207-215.